



1

MEASUREMENT IN SCIENCE AND TECHNOLOGY

Measurement is a basic skill which forms an essential part of our day to day activities irrespective of what we do. You would definitely have observed that while cooking food, measured quantities of ingredients are cooked for a measured amount of time. When you go to buy fruits and vegetables, you take them in measured amounts. You can identify which one of your friends runs fastest. This is possible by making them run a known distance say from one end of a playground to the other and noting who is first to reach the destination. In other words, you measure the time. Can you tell by the above measurement how fast does your friend run? For this, you need to precisely measure the distance run and the time taken. Science and technology helps us in making precise measurements for our daily life activities such as stitching, cooking, sports, shopping, travelling etc.

In this lesson we would like to seek answers to several questions. What is the measurement and why do we need it? How do we measure? How do we quantify a measurement, so that it is understood by everyone in the same sense? What is the currently accepted International System of units? We would also learn about commonly used tools for measurement of the physical quantities like length, mass, time, area and volume.



OBJECTIVES

After completing this lesson, you will be able to:

- *define measurement and explain the need for measurement;*
- *give examples of the parts of human body that may be used to measure length of an object and state the limitations of such measurements;*
- *describe the Indian and various other measurement systems used in the ancient times;*
- *explain the need of a common system of units;*
- *define and differentiate base and derived SI units;*



Notes

- derive the SI unit of a physical quantity;
- explain the need of SI prefixes;
- use SI prefixes for the units and
- correctly write the SI units using the rules for writing the same.

1.1 WHAT IS A MEASUREMENT?

Suppose you are asked to measure the length of a play ground, what would you do? May be you would walk from one end of the field to the other and count the number of steps. The other possibility is that you may arrange for a measuring tape or some scale, say a meter scale. Then again go from one end and count how many times the meter scale was used to reach the other end. Let us take another example. Suppose you need to weigh a carton full of books; you would use a weighing scale and see how many kilogram weights you need to correctly weigh the carton- again a kind of counting. Thus we may define measurement to be **a counting of the number of times a chosen scale is used.**

“When you can measure what you are talking about, and express in numbers, you know what you are talking about; but when you cannot measure it, when you cannot express it in numbers, your knowledge is of a meagre and unsatisfactory kind; it may be the beginning of knowledge, but you have scarcely, in your thoughts, advanced to the stage of a Science”

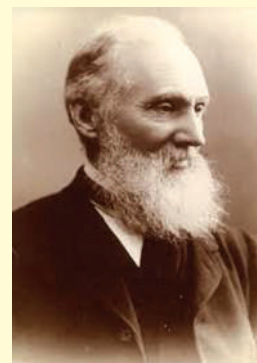

Lord Kelvin (1824-1907)

1.1.1 Why do we need to make a measurement?

Suppose you go to the market to buy mangoes and they are priced at say Rs.50 per kilogram. What would you expect the shopkeeper to do? Would you be happy if he/she gives you 4 or 5 small mangoes, which are surely less than a kilogram, and asks for the price of one kilogram? Similarly, the shopkeeper will also not like to give you more than a kilogram of mangoes for the price of a kilogram. An accurate measurement is desirable for both buyer and the seller. The absence of a suitable measurement may lead to conflicts between them. Measurement is an essential activity in our everyday life. You may ask why it is essential. Can't we do without it?

Have you ever wondered how space scientists make sure that the space shuttle reaches the desired destination? Or when the shuttle comes back it comes at a predetermined time and place. This is made possible by accurate measurement of many parameters and extensive calculations. For measurement we require specific scale which is called unit.

1.1.2 What is a Unit?

Imagine a situation. Suppose you are blindfolded and handed a bunch of currency notes. On counting them you find that they are 46 in number. Can you tell how much money is in your hand? For knowing the exact amount of money, you need to know the denomination i.e., whether the notes are of Rs.10, Rs.50, Rs100 or of some other denomination?

Similarly, if you are told that two trees are 100 away from each other. How would you interpret it? Are the trees 100 cm, 100 ft or 100 m or ...away? These examples suggest that the result of every measurement must be expressed in such a way that it makes a sense and has a unique meaning. For this we need to know two things. Firstly, what is the measuring standard used, say centimetre (cm), metre (m) or foot (ft) in the above example and the number of times it is used.

The result of measurement of a physical quantity is expressed in terms of a **value**. The value of the physical quantity is equal to the product of the number of times the standard is used for the measurement and the quantity (the standard) defined for making the measurement. This defined or standard quantity i.e., the scale used e.g., metre or the foot in above case, is called a unit.

$$\text{Value of physical quantity} = \text{numerical quantity} \times \text{unit}$$

A unit is a measure, device or a scale in terms of which we make physical measurement. The value of a physical quantity consists of two parts; a numerical quantity and a unit and is equal to their product.

Thus, it is necessary to state the numerical quantity as well as the unit while expressing the result of a measurement. So by now we know that the measurements are essential in every sphere of human activity and also that we need a unit or a standard in terms of which we make the measurement and express the result of such a measurement. Let us learn about the characteristics of such a unit. What qualities should a unit have?

1.1.3 Characteristics of a Unit

Can we measure the distance in kilograms? Obviously not; it is ridiculous to measure distance in terms of kilogram. It has no relevance for measuring distances. So to be useful, a unit should be **relevant** for the quantity being measured. Further, the unit used should be **convenient** also. Would it be convenient to express the distance between two cities in inches? Don't you think that kilometre would be a better unit? In addition to being relevant and convenient a unit should also be **well defined** i.e. it should be well understood by other people. For example, we may express the distance between my house and a nearby shop as 200 steps. In order to make some sense, we need to define the step - whether it is my step or an adult and child. Is it while walking slowly or while running fast? How long is the step? Thus, to be useful, a unit must be:

- relevant
- convenient
- well defined



Notes



Notes

In today’s world, an accurate measurement is a necessary. We have innumerable devices to make such measurement. You would be surprised to know that an atomic clock is so accurate that it may make an error of just one second in about 15 million years. Have you ever thought how our ancestors made measurements? What were the devices used and what the units of measurement? Let us try to learn about the interesting way measurements were made and also the way the system of measurement has evolved since then. However, why don’t you assess your understanding of the meaning and need of measurement and about the units and their characteristics.



INTEXT QUESTIONS 1.1

1. Define the term measurement by giving two examples.
2. What is a unit?
3. List the essential characteristics of a unit.

1.2 HOW DID OUR ANCESTORS MAKE MEASUREMENTS?

The need for measurement and measuring devices dates back to antiquity. When the humans became civilised, started cultivating and living in communities they realised that one cannot do everything and they need to be interdependent. This paved the way for trade and then probably a need of a measure was felt. Various ways of measurements were adopted. The system of measurement has evolved a lot since then. Let us have a brief account of interesting means of measurement used by our forefathers.

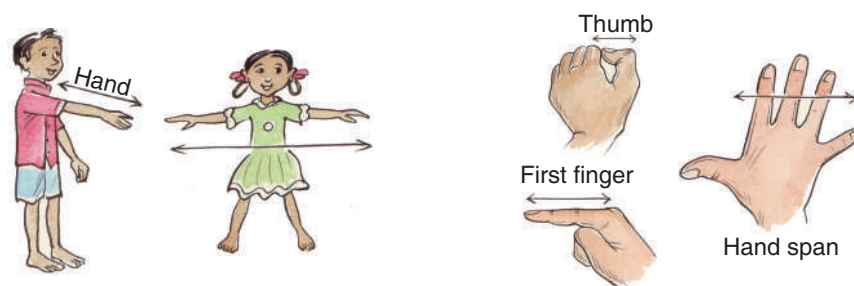

Fig. 1.1 Use of body parts for measurements

The recorded history shows ample evidence that the different parts of the human body were used as a point of reference while making measurements. Some of these were, digit : the width of a single finger; foot : the length of a foot; cubit: length of an arm; hand span : the distance between the tip of the thumb and the tip of the little finger when the hand is fully stretched out. similarly fathom meant the distance



Notes

between the ends of the hands of a Anglo-Saxon farmer when his arms were fully out stretched. It is interesting to note that these are still used sometimes.

Certain historical units were based on the things around us, e. g., Romans used a unit called pace which was equal to the stride of their army contingent and they called the distance travelled by it in 1000 paces to be equal to a mile. Similarly, the grain was used as the unit of mass in sixteenth century and was equal to the weight of a wheat grain.

Based on the criteria given under section 1.1.3, evaluate the above units. What are the limitations you find in above ancient units of measurement? Write your response in the space given below.

.....

.....

.....

.....

The following activity may help you to respond to the above query. Perform the following activity and then revisit your response above.



ACTIVITY 1.1

Can you check the accuracy of the measurements using parts of your body as a unit? In your personal contact programme (PCP) you can perform this. Take a black board (or a table, a desk, a wall or any other suitable reasonably long object) with group of 4-5 learners.

This activity can be performed in the class or even at home. In the class a group of 4-5 students can participate in it. (At home the family members or friends can do the same).

First measure the length of the black board using hand span and digits as the units of measurement and record your observations in the table given below.

S. No.	Name of the learner	Length of the black board* in Hand span and digits e.g., 10 Hand spans and 3 digits
1		
2		
3		
4		
5		

* or any other object on which the measurement is made



Notes

Now ask your friends (or other learners of the group) to make the same measurement one by one and record their results in the table above. Thus you can record your body **can/cannot** be used for accurate measurements based on your observation. (Tick the right option and delete the incorrect one)

Would you like to revisit your response given above and revise?

1.2.1 Need for a standard unit

As you would have concluded from the activity given above, the units based on parts of human body are arbitrary and inaccurate. The results of the measurements vary from person to person because size of the unit is different for different person. For example, the units like a cubit or a foot would depend on the person making measurement. This created problems in trade between different countries and obviously in the day to day transactions. In order to overcome the limitations of body parts as units, and to bring about uniformity in the measurement system, the need for exact measurement was felt. For this, a standard of measurements had to be developed which is acceptable to everybody.

The problem of measuring lengths accurately was first solved by the Egyptians as far back as in 3000 B.C. It was done by defining the standard cubit. It was defined to be equal to the distance between the elbow and tip of the middle finger of the Pharaoh ruling Egypt at that time. Measuring sticks of length exactly equal to that of standard cubit were made. In this way they made sure that the cubit was the same length all over Egypt. Similar efforts were made by other rulers also. For example, the British King Henry-I (1100-1137) decreed that a yard would exactly be equal to the distance from the top of his nose to the end of his thumb on outstretched arm. Queen Elizabeth-I declared a mile to be exactly equal to eight furlongs. A furlong (furrow long) was the distance a pair of oxen could plough in a field without stopping to rest. It was found to be 220 yards.

These standards proved to be useful but were short lived, as once a given ruler went out of power or died, the system was not followed and a newer system came into being. Further, since different countries and the different provinces in a given country were governed by different rulers; they followed different systems of units. As a consequence, by the eighteenth century a large number of units for mass, length, area and volume came to be in widespread use. Let us now learn about the systems of units followed in India in different historical periods.

1.2.2 Indian measurement system

The measurement system in India also has evolved a great deal from the ancient times.

(a) Indian measurement system in the ancient period

In ancient periods in India, the lengths of the shadows of trees or other objects were used to know the approximate time of the day. Long time durations were expressed

in terms of the lunar cycles, which even now is the basis of some calendars. Excellent examples of measurement practices in different historic periods are available. For example, about 5000 years ago in the Mohenjodaro era, the size of bricks all over the region was same. The length, breadth and width of bricks were always in the ratio of 4:2:1 and taken as a standard .

Similarly around 2400 years ago during the Chandragupta Maurya period there was a well-defined system of weights and measures. The government at that time ensured that everybody used the same weights and measures. According to this system, the smallest unit of length was 1 Parmanu. Small lengths were measured in anguls. For long distances Yojan was used. One Yojan is roughly equal to 10 kilometres..

Different units of measurements used in the period of Chandragupta Maurya

8 Parmanus	=	1 Rajahkan (dust particle from the wheel of a chariot)
8 Rajahkans	=	1 Liksha (egg of lice)
8 Likshas	=	1 Yookamadhya
8 Yookamadhyas	=	1 Yavamadhya
8 Yavamadhyas	=	1 Angul
8 Anguls	=	1 Dhanurmushti

(Reference: Kautilaya's *Arthashastra*)

The Indian medicine system, Ayurveda, also had well-defined units for the measurement of the mass and volume. The measurement system was strongly followed to ensure the proper quantity of medicine for particular disease.

(b) Indian measurement system in the medieval period

In the medieval period also the measurement system was in practice. As described in **Ain-i-Akbari** by Abul Fazl-i-Allami, during the period of Moghul Emperor Akbar, the gaz was used as the unit of measuring length. Each gaz was divided into 24 equal parts and each part was called Tassuj. This system was extensively used to measure land pieces, for construction of buildings, houses, wells, gardens and roads. You should know that, the gaz was widely used as a unit of length till the metric system was introduced in 1956. Even today in many parts of our country, particularly in the rural areas, gaz is being used as a unit of length.

(c) Indian measurement system during British period

In order to bring about uniformity in the system of measurement and the weights used, a number of efforts were made during the British period. The British rulers wanted to connect Indian weights and measures to those being used in Great Britain at that time. During this period the inch, foot, and yard were used to measure length whereas



Notes



Notes

grain, ounce, pounds, etc. were used to measure mass. These units and weights were used in India till the time of Independence in 1947. The essential units of mass used in India included Ratti, Masha, Tola, Chhatank, Seer and Maund. Raatti is a red seed whose mass is approximately 120 mg. It was widely used by goldsmiths and by practitioners of traditional medicine system in India.

Relation between various units of mass used during the British period

8 Ratti	1 Masha
12 Masha	1 Tola
5 Tola	1 Chhatank
16 Chhatank	1 Seer
40 Seer	1 Maund
1 Maund	100 Pounds troy (exact)



INTEXT QUESTIONS 1.2

1. Name the smallest unit of length during the Chandragupta Maurya period.
2. List the parts of human body which can be used for measurements.
3. Why cannot the parts of human body be used for accurate measurement?
4. In which period was 'gaz' introduced as a unit to measure length?

1.3 THE MODERN MEASUREMENT SYSTEMS

Immediately after the French Revolution (1790) the French scientists took lead in establishing a new system of weights and measures. They advocated the establishment of national standards for the purpose and the use of decimal arithmetic system. This led to the birth of metric system which like our Hindu-Arabic counting system is based on the multiples and subdivisions of ten.

After detailed deliberations the basic unit of length and mass were defined and their working standards were prepared. The working standard for meter was prepared by marking two lines a metre apart, on a platinum-iridium bar. Similarly, a platinum - iridium cylinder was constructed, equal to the mass of 1 cubic decimetre of water, as the working standard for mass. These two standards have been preserved at the International Bureau of Weights and Measures at Sèvres near Paris. The copies of these were prepared and sent to different countries. As regards the time, the concept of hour, minute and second based on

The meter was defined as one ten millionth ($1/10^7$) of the distance between north pole to the equator on the meridian running near Dunkirk in France and Brcelona in Spain.

the rotation of earth was retained. An international treaty, called Metre Convention was signed in 1875 to follow metric system through out the world for trade and commerce.

In the course of development of units a number of systems were adopted. Two systems which were extensively used were the cgs and mks systems. The cgs system was based on centimetre, gram and second as the units for length, mass and time while mks system used metre, kilogram and second for the same. In 1958 it was realised that the units defined as standard needed to be redefined. Since 1983, it is defined as the length of the path travelled by light in vacuum in $1/299,792,458$ of a second. The new exercise of redefining the system of units led to the birth of SI system of units which is currently the system in use. Let us learn the SI system in details.



Notes

1.4 SI UNITS

An international system of units, called SI units, was adopted at the 11th General Conference on Weights and Measures (CGPM) in 1960. SI is an abbreviation of the French name “Le Systeme Internationale de Unite’s”.

You know that measurements are concerned with quantities like length, mass, time, density etc. Any quantity which can be measured is called a physical

The base SI units are independent of each other

quantity. The SI system of units is based on seven **base units** corresponding to seven base physical quantities. These are the physical quantities, in terms of which other physical quantities can be measured. The names and symbols of the base physical quantities and their corresponding SI units are given in Table 1.1. The precise definitions and the standards for the base SI units are given under Appendix-I.

Table 1.1 Names and symbols of the base physical quantities and the corresponding SI units.

Base physical quantity	Symbol of Physical quantity	Name of SI Unit	Symbol for SI Unit
length	l	metre	m
mass	m	kilogram	kg
time	t	second	s
electric current	I	ampere	A
thermodynamic temperature	T	kelvin	K
amount of substance	n	mole	mol
Luminous intensity	I	candela	cd

Note: The other measurements for temperature are in degree celsius ($^{\circ}\text{C}$) and Fahrenheit (F).



Notes

Perhaps you may be confused by mass and amount of substance and also with luminous intensity as given in Table 1.1. The mass of a body is the amount of matter contained in the body, while a mole is the amount of any substance equal to its molecular mass expressed in grams. For example,

$$1 \text{ mole of HCl} = 36.46 \text{ g}$$

$$2 \text{ moles of HCl} = 36.46 \times 2 = 72.92 \text{ g}$$

Luminous intensity is the amount of light emitted by a point source per second in a particular direction.



ACTIVITY 1.2

Take a thermometer at your home. Observe the measuring marks on a thermometer along with a parent.

- (i) Write down the two types of measuring marks indicating on the thermometer.
- (ii) Measure your temperature and record it in °C (degree celsius) and F (Fahrenheit)
- (iii) In case you find it difficult to understand, you can contact your nearest Doctor or nurse or ANM

Note: Commonly, body temperature between 98.2°F-98.6°F is expressed in Fahrenheit.

1.4.1 Derived Units

The base or fundamental SI units like length, mass, time, etc. are independent of each other. The SI units for all other physical quantities such as area, density, velocity can be derived in terms of the base SI units and are called **derived units**. In order to find the derived unit for a physical quantity we have to find out the relationship between the physical quantity and the base physical quantities. Then substitute the units of the base physical quantities to find the desired derived unit. Let us take some examples to learn how to derive units for physical quantities in terms of base units.

Example 1. Derive the SI unit for area of a surface.

In order to derive the unit, we need to find out the relationship between area and the base physical quantities. As you know that the area of a surface is the product of its length and breadth. So, as the first step we write area as

$$\text{Area} = \text{length} \times \text{breadth}$$

Since breadth is also a kind of length, we can write,

$$\text{Area} = \text{length} \times \text{length}$$

Then to find the derived unit for area, we substitute the units of the base physical quantities as

$$\text{Unit of area} = \text{metre} \times \text{metre} = (\text{metre})^2 = \text{m}^2$$

Thus, the SI unit of area is m^2 and is pronounced as squared metre. Similarly you can check that volume would have the SI unit as m^3 or cubic metre.

Example 2. Find the derived unit for force.

You know that force is defined as

$$\text{Force} = \text{mass} \times \text{acceleration} = \text{mass} \times (\text{change in velocity}/\text{time})$$

Since, $\text{change in velocity} = \text{Length}/\text{time}$

So, $\text{Force} = \text{mass} \times (\text{length}/\text{time}) \times (1/\text{time}) = \text{mass} \times (\text{length}/\text{time}^2)$

The SI unit of force can be found by substituting the SI units of the base physical quantities on the right side of the expression.

Thus, \Rightarrow SI unit of force = $\text{kg m/s}^2 = \text{kg ms}^{-2}$

Some commonly encountered physical quantities other than base physical quantities, their relationship with the base physical quantities and the SI units are given in Table 1.2.

Table 1.2 Some examples of derived SI units of the commonly used physical quantities

Derived Quantity	Dimensions	Name of Unit	Symbol of the Unit
area	Length \times length	square meter	m^2
volume	Length \times length \times length	cubic metre	m^3
speed, velocity	Length/time	metre per second	m s^{-1}
acceleration	(Length/time)/time	metre per second squared	m s^{-2}
wavenumber	1/length	reciprocal metre	m^{-1}
density	Mass/(length) ³	kilogram per cubic metre	kg m^{-3}
Work	(Mass \times length ²)/(time) ²	kilogram square metre per square second	$\text{kg m}^2/\text{s}^2$

A number of physical quantities like force, pressure, etc. are used very often but their SI units are quite complex. Due to their complex expression it becomes quite inconvenient to use them again and again. The derived SI units for such physical quantities have been assigned special names. Some of the physical quantities whose SI units have been assigned special names are compiled in Table 1.3.



Notes



Notes

Table 1.3 Names and symbols of the derived SI units with Special names

Physical Quantity	Derived SI unit	Special name assigned to the Unit	Symbol assigned to the special name
frequency	s^{-1}	Hertz	Hz
force	$m.kg.s^{-2}$	Newton	N
Pressure or stress	$m^{-1}.kg.s^{-2}$	Pascal	Pa
Energy or work	$kg.m^2.s^{-2}$	Joule	J
Power	$kg.m^2.s^{-3}$	Watt	W



INTEXT QUESTIONS 1.3

1. Differentiate between base units and derived units.
2. What is the difference between mass and amount of a substance?
3. Derive the unit of Pressure. (Pressure = Force/Area)
4. Which term of measurement is commonly used by the announcer of your favourite radio programme?
5. Observe a bulb/tube light at your home for the unit measurement written on it. From Table 1.3 find out the physical quantity it measure?
6. Veena, Mohindar and Alam went to market. Veena brought milk with a litre measure, Mohindar brought ribbon by a measuring mark on the table and Alam brought vegetables using stones. Which of them did not use the appropriate measurement while purchasing goods? Explain while given the names of right measurement.

1.4.2 SI Prefixes

When we make measurements of physical quantities, quite often the quantity being measured is too large as compared to the base unit of the physical quantity. Look at some of the following examples,

Mass of earth = 5,970,000,000,000,000,000,000 kg

Radius of Sun = 6,96,000,000 m

Approximate distance between Mumbai and Delhi = 1,400,000 m

Other possibility is that the physical quantity is too small as compared to the base unit of the physical quantity. Look at some of the examples,

Radius of a hydrogen atom = 0.000,000,000,05 m

Mass of an electron (m_e) = 0.000,000,000,000,000,000,911 kg

You can see from the examples given above that when the physical quantity being measured is either too large or too small as compared to the standard unit, then the value of the physical quantity is quite inconvenient to express.

The numbers given above can be simplified by using what is called scientific notation of numbers. In this notation system we represent the numbers as power of ten. In this notation system we can rewrite the above examples as

$$\text{Mass of Earth} = 5.97 \times 10^{24} \text{ kg}$$

$$\text{Radius of Sun} = 6.96 \times 10^8 \text{ m}$$

$$\text{Approximate distance between Mumbai and Delhi} = 1.4 \times 10^6 \text{ m}$$

$$\text{Radius of a hydrogen atom} = 5 \times 10^{-11} \text{ m}$$

$$\text{Mass of an electron (} m_e \text{)} = 9.11 \times 10^{-31} \text{ kg}$$

In scientific notation the numbers become relatively easier, but are still not convenient because they carry exponents. In order to simplify the numbers further, the SI system of units has recommended the use of certain prefixes. These prefixes are used along with the SI units in such a way that the physical quantity being measured can be expressed as a convenient number. The SI prefixes have been defined to cover a wide range of 10^{-24} to 10^{+24} of a unit and are given in Table 1.4.

Table 1.4: SI Prefixes for multiples and sub multiples of units

Multiple	Prefix	Symbol	Sub multiple	Prefix	Symbol
10^{24}	yotta	Y	10^{-1}	deci	d
10^{21}	zetta	Z	10^{-2}	centi	c
10^{18}	exa	E	10^{-3}	milli	m
10^{15}	peta	P	10^{-6}	micro	μ
10^{12}	tera	T	10^{-9}	nano	n
10^9	giga	G	10^{-12}	pico	p
10^6	mega	M	10^{-15}	femto	f
10^3	kilo	k	10^{-18}	atto	a
10^2	hecto	h	10^{-21}	zepto	z
10^1	deca	da	10^{-24}	yocto	y

1.4.3 How do we use SI prefixes?

In order to use SI prefixes, we have to keep a basic rule in mind. The rule is that the prefix is chosen in such a way that the resulting value of the physical quantity has a value between 0.1 and 1000. Let us illustrate it with examples.



Notes



Notes

Radius of Sun = $6.96 \times 10^8 \text{ m} = 696 \times 10^6 \text{ m} = 696 \text{ Mm}$ (696 mega metre)

Alternatively = $6.96 \times 10^8 \text{ m} = 0.696 \times 10^9 \text{ m} = 0.696 \text{ Gm}$ (0.696 giga metre)



INTEXT QUESTIONS 1.4

Rewrite the following measurements of length using suitable SI prefixes.

- effective radius of a proton; $1.2 \times 10^{-15} \text{ m}$ _____
- radius of human red blood cell; $3.7 \times 10^{-6} \text{ m}$ _____
- radius of our galaxy; $6 \times 10^{19} \text{ m}$ _____

You must follow the following rules while using SI prefixes.

Note:

- No space is required between the prefix and the symbol of the unit e.g., nanogram is written as ng and not as n g.
- The prefixes are used only with the units and not alone e.g., 10μ does not convey anything, it has to be $10 \mu\text{m}$, $10 \mu\text{g}$, etc.
- You can use only one prefix at a time e.g. 10^{-12} g is represented as 1 pg and not as 1 mmg .
- SI prefix is not used with the unit $^{\circ}\text{C}$.
- The power to which a prefixed unit is raised applies to the whole unit, including the prefix e.g. $1 \text{ km}^2 = (1000 \text{ m})^2 = 10^6 \text{ m}^2$ and not 1000 m^2 .

Having learnt about the base SI units, the method of obtaining the derived SI unit for a given physical quantity and also the need and usage of prefixing SI units, let us now learn about the grammatical rules for using SI units in general.

1.4.4 Rules for Representing SI Units

The SI units are the result of the attempt of scientists to evolve a common international system of units that can be used globally. It is therefore important that the words and the grammar is logical and defined unambiguously i.e. everyone uses the system of units in the same manner. In order to achieve this objective, a number of grammatical rules have been framed. The most commonly used rules are given below:

- While writing the value of physical quantity, the number and the unit are separated by a space. For example, 100 mg is correct but not 100mg .
- No space is given between number and $^{\circ}\text{C}$, degree, minute and second of plane angle.
- The symbols of the units are not changed while writing them in plural e.g. 10 mg is correct but not 10 mgs .



Notes

- The symbols of the units are not followed by a full stop except at the end of a sentence, e.g. 10 mg. of a compound is incorrect.
- In writing the SI unit obtained as a combination of units a space is given between the symbols. Thus m s represents metre second while ms stands for milli-second. That is if the units are written without leaving any space, the first letter may be taken as a prefix.
- For numbers less than unity zero must be inserted to the left of the decimal point e.g. writing 0.928 g is correct but not .928 g.
- Symbols of units derived from proper names are represented by using capital letters. When written in full, the unit should not be written in plural e.g. 30.5 joule or 30.5 J is correct but 30.5 Joules or 30.5 j is not correct.
- When using powers with a unit name the modifier squared or cubed is used after the unit name e.g. second squared, gram cubed etc. Area and volume are exception in such cases the qualifier for the power comes first e.g. square kilometer or cubic centimetre etc.
- For representing unit symbols with negative exponent, the use of the solidus (/) sign should be avoided. If used, no more than one solidus should be used e.g. the unit for gas constant ($\text{JK}^{-1} \text{mol}^{-1}$) may be represented as J/K mol but not as J/K/mol .

The rules mentioned earlier for the use of SI prefixes are to be followed along with these rules.



WHAT YOU HAVE LEARNT

- Measurement is a basic skill which forms an essential part of our day to day activities irrespective of what we do.
- It is a process of comparison and involves counting of the number of times a chosen scale is used to make the measurement.
- Measurement is essential for accurate determination of a physical quantity. It is helpful in day to day transactions, trade and scientific endeavours.
- The unit of physical quantity is a standard value in terms of which other quantities of that kind are expressed.
- To be useful, a unit must be relevant to the quantity being measured, be convenient and also well defined so that it is understood by every body in an unambiguous way.
- In the ancient times parts of 'human body' were used for measurement but these led to conflicts and confusions because these were arbitrary, non uniform and led to results which were not reproducible.



Notes

- Currently, we follow an international system of units, called SI units. This system is based on seven base units which correspond to seven base physical quantities namely length, mass, time, temperature, amount of substances, light intensity and electric current.
- The units for all other physical quantities can be derived in terms of the base SI units and are called derived units. Some of the derived units have been given special names.
- SI prefixes are used in cases where the quantity being measured is too large or too small as compared to the base unit of the physical quantity.
- The grammar of SI units must be followed while writing them.



TERMINAL EXERCISE

- Which of the following is not an SI unit?

A. Metre	B. Pound
C. Kilogram	D. second
- If the mass of a solution in $10 \mu\text{g}$ it is the same as

A. 10^{-6} g	B. 10^{-12} g
C. 10^{-9} g	D. 10^{-3} g
- Indicate whether the following statements are True or False. Write T for true and F for false

(i) SI units are arbitrary	(ii) $1 \text{ mm}^2 = 10^{-3} \text{ m}^2$
(iii) $10^{-15} \text{ g} = 1 \text{ mpg}$	(iv) SI unit for pressure is Pascal
- Represent the following measurements by using suitable SI prefixes

(i) $2 \times 10^{-8} \text{ s}$	(ii) $1.54 \times 10^{-10} \text{ m}$
(iii) $1.98 \times 10^{-6} \text{ mol}$	(iv) 200 000 kg
- Give the SI units used while buying :.

A. Silk ribbon	B. Milk
C. Potatoes	
- Give the common unit to measure our body temperature and write its SI unit
- What are the advantages of SI units?

APPENDIX-I

- (a) **Mass:** The SI unit of mass is kilogram. One kilogram is the mass of a particular cylinder made of Platinum–Iridium alloy, kept at the International Bureau of Weights and Measures in France. This standard was established in 1887 and



Notes

there has been no change because this is an unusually stable alloy. Prototype kilograms have been made out of this alloy and distributed to member states. The national prototype of India is the Kilogram no 57. This is preserved at the National Physical Laboratory, New Delhi.

- (b) **Length:** The SI unit of length is metre. Earlier the metre (also written as meter) was defined to be $1/10^7$ times the distance from the Equator to the North Pole through Paris. This standard was abandoned for practical reasons. In 1875, the new metre was defined as the distance between two lines on a Platinum-Iridium bar stored under controlled conditions. Such standards had to be kept under severe controlled conditions. Even then their safety against natural disasters is not guaranteed, and their accuracy is also limited for the present requirements of science and technology. In 1983 the metre was redefined as the distance travelled by light in vacuum in a time interval of $1/299792458$ seconds. This definition establishes that the speed of light in vacuum is 299792458 metres per second.
- (c) **Time:** The SI unit of time is second. The time interval second was originally defined in terms of the time of rotation of earth about its own axis. This time of rotation is divided in 24 parts, each part is called an hour. An hour is divided into 60 minutes and each minute is subdivided into 60 seconds. Thus, one second is equal to $1/86400^{\text{th}}$ part of the solar day. But it is known that the rotation of the earth varies substantially with time and therefore, the length of a day is a variable quantity, may be very slowly varying.
- The XIII General Conference on Weights and Measures in 1967 defined one second as the time required for Cesium-133 atom to undergo 9192631770 vibrations. The definition has its roots in a device, which is named as the atomic clock.
- (d) **Temperature:** The SI unit of temperature is kelvin (K). The thermodynamic scale on which temperature is measured has its zero at absolute zero, and has its lower fixed point corresponding to 273.15 K at the triple point of water (0°C). One unit of thermodynamic temperature (1K) is equal to $1/273.15$ of the thermodynamic temperature of the triple point of water.
- (e) **Electric current:** The SI unit of electric current is the ampere (A). One ampere is defined as the magnitude of current that when flowing through two long parallel wires, each of length equal to 1 m, separated by 1 metre in free space, results in a force of 2×10^{-7} N between the two wires.
- (f) **Amount of substance:** The SI unit of amount is mole (mol). One mole is defined as the amount of any substance, which contains, as many elementary units, as there are atoms in exactly 0.012 kg of C-12 isotope of carbon.
- (g) **Luminous intensity:** The SI unit of luminous intensity (I) is candela (Cd). The candela is defined as the luminous intensity, in a given direction, of a source that emits monochromatic radiation of frequency 540×10^{12} hertz and that has a radiant intensity of $1/683$ watt per steradian in that direction.



ANSWERS TO INTEXT QUESTIONS

1.1

1. Measurement may be defined as a kind of counting. It refers to counting of the number of times a chosen scale is used to make the measurement. For example :An inch tape to measure length, or a graded cylinder to measure volume.
2. A unit is a measure, device or a scale in terms of which we make physical measurement.
3. A standard unit must have the following characteristics to be useful
 - relevant
 - convenient
 - well defined

1.2

1. Parmanu
2. Arm, Angul, Cubit, etc.
3. Because the parts of human body may vary from person to person and we cannot trust on our senses to measure exactly and accurately.
4. During the period of Moghul emperor Akbar.

1.3

1. (a) Fundamental units are only seven in number whereas derived units are very large in number.
(b) Fundamental units are independent of each other but derived units are obtained from fundamental units.
2. Mass of a body is the amount of matter contained in a body while the amount of the substance is equal to its molecular mass.
3. Unit of pressure = Unit of force/Unit of area = $\text{kg ms}^{-2} / \text{m}^2 = \text{kg m}^{-1}\text{s}^{-2}$
4. Hz
5. Watt
6. Mohindar and Alam, meter scale, kilogram

1.4

- (i) 1.2 fm (ii) 3.7 mm (iii) 60 E m

For more information:



“Kahani Maap Tol Ki” Vigyan Prasar Publication www.vigyanprasar.gov.in

MODULE - 2

MATTER IN OUR SURROUNDINGS

2. Matter in our Surroundings
3. Atom and Molecules
4. Chemical Reaction and Equations
5. Atomic Structure
6. Periodic Classification of Elements
7. Chemical Bonding
8. Acids, Bases and Salts



2

MATTER IN OUR SURROUNDINGS

You have learnt about units of measurement in the previous lesson. What we eat, drink or breathe is the matter. Hence all of us are surrounded by matter. *Anything which occupies space and has mass is matter.* In order to understand the world better it is necessary to understand the *nature of matter.*

In this section you shall learn about matter and shall utilise the concepts of measurement in understanding the properties of matter.



OBJECTIVES

After completing this lesson you will be able to:

- describe what is matter and explain its particulate nature;
- clarify and differentiate the three states of matter – solid, liquid and gas;
- describe the effect of pressure and temperature on states of matter;
- illustrate the inter-conversion of these states with the help of suitable examples;
- classify the given matter as an element, a compound or a mixture;
- distinguish between homogeneous and heterogeneous mixtures;
- define the terms solution, solvent and solute;
- calculate the percentage composition of a solution;
- describe the properties and uses of suspension, and
- describe the common methods used for separation of mixtures or purification of a substance.



Notes

2.1 WHAT IS MATTER?

Matter is any thing which has mass and occupies space. All solids, liquids and gases around us are made of matter. Scientist believe that matter is made of tiny particles that clump together. You cannot see these particles but you can see the matter, for example, a book, a car, a letter, a hand set, a piece of wood, tree, a bag etc. Think and add a few more exmaples from your day to day life.

When we say matter has mass it means matter has weight: the heavier an object, the more mass it has. Matter occupies space it means matter has volume.

A substance is a pure kind of matter having only one kind of constituent particle (atom or molecule). Water, iron, gold, copper, aluminum and oxygen are examples of substances. **All substances are matter but all forms of matter are not substances.** You must be wondering how this is possible. Well, a substance is a pure form of matter, that is, it is the same throughout. Let us take the examples of soft drinks and soil. In what category you would put them. They are not single substance but they are mixture of substances. Now you will find out what is the nature of matter?

2.2 PARTICULATE NATURE OF MATTER

Human beings have been questioning the nature of matter. In ancient times there were two different views about it. One school of thought believed that if we take a piece of matter (for example stone) and break it into smaller pieces and break these smaller pieces into still smaller pieces, the process can be repeated any number of times. This would happen because matter is continuous and its piece of any size can be broken or subdivided into smaller pieces. Greek philosophers Plato and Aristotle belong to this school of thought.

The second school of thought believed that process of subdivision of matter can be repeated only for limited number of times. A stage would be reached when the tiny particles of matter so obtained cannot be further subdivided. They believed that all matter is composed of very tiny particles. In other words, the matter has particulate nature. The smallest indivisible particles of matter were given the name “atom” from the Greek word “atomos” for “indivisible“ .

Indian philosopher Kanada and Greek philosophers Leucippus and Democritus belong to this school of thought. The term “atom” was coined by Democritus. Today the idea of atom has changed since it was first proposed. The modern idea of atom originated with John Dalton in 1803. Today we talk of two types of constituent particles-atoms and molecules. Atoms is a basic unit of matter and all chemical

properties of matter can be explained on its basis. Molecules are important in explaining physical properties of matter. Details about atoms and molecules will be undertaken in the Lesson No. 3. Let us learn about how to classify matter.



INTEXT QUESTIONS 2.1

1. What is matter?
2. Which of the following is not a pure substance?
(a) Iron (b) Water (c) Soil
3. Who coined the term “atom” and what does it mean?

2.3 STATES OF MATTER

Matter can be classified in many ways. However, the following are the two main ways of classifying the matter:

- (i) by the physical state of matter as a solid, liquid, or gas, and
- (ii) by the chemical composition of matter as an element, compound or mixture.

We shall discuss these classifications in the next section.

Let us discuss about the classification of matter based on physical states. Matter can ordinarily exist in three states – solid, liquid and gas. These three states of matter have different properties. Water exists in all the three states namely steam or water vapour (gas), water at room temperature (liquid) and ice (solid). This is the only substance which exists naturally in all the three states.

The characteristic properties of different states of matter depend on intermolecular forces. **The forces holding molecules together are called intermolecular forces.** Intermolecular forces (i.e. forces between the constituent molecules) try to keep molecules together but thermal energy always tries to keep them far apart. It is the competition between molecular interaction energy and thermal energy that decides whether a given substance under given conditions will be a solid, liquid or gas. Thermal or heat energy can convert one state of matter into another state. Thus a particular state of a matter depends on both : intermolecular force and the thermal energy which basically depends upon temperature.

Each state of matter has some characteristic properties. Now you shall learn about these properties.



Notes



Notes

2.3.1 Solids

We are surrounded by innumerable solid objects. A piece of wood, a stone, a pencil, a pen, and a computer all are examples of solids. **A solid has definite size and shape which do not change on their own** (see Fig.2.1). However, by using external forces you can change the shape of a solid. For example you can cut a piece of metal into two and you can use hammer to change its shape. Can you think of any other way to change the shape of solids? Yes, you can. Beat it into sheets or pull it into strings.

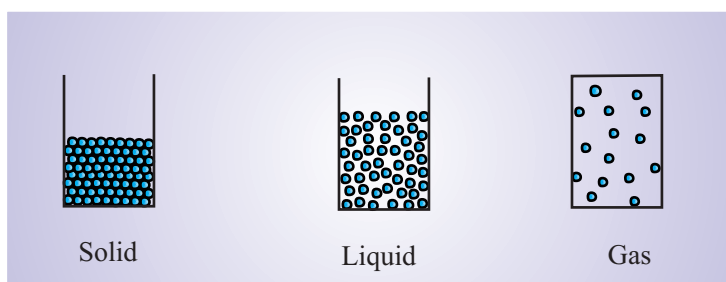

Fig. 2.1: Shapes of different states of matter

In solids the constituent particles are present very close to each other and the intermolecular forces operating between the constituent particles are very strong and they are capable of keeping the molecules in fixed positions. This is the reason why solids are rigid and hard. Also, solids cannot be compressed. The attractive intermolecular forces become repulsive when atoms or molecules are forced to come further closer. When a solid is heated there is an increase in thermal energy of the particles which results in conversion of solid into liquid. The temperature at which this happens is the **melting point** of the solid.

2.3.2 Liquids

Water is a liquid. Mustard oil and kerosene oil are other examples of liquids. Can you think of some more examples? **A liquid has a definite volume.** However, a liquid does not have a definite shape. It takes the shape of its container. A liquid can flow. You can pour a liquid or spill it. Can you spill a solid?

Liquids have properties intermediate between solids and gases. The intermolecular forces in liquids are weaker than solids but stronger than gases. In liquids the constituent particles do not occupy fixed position as in solids, but they have freedom of movement as in gases. In liquids intermolecular forces are stronger than those of gases. The constituent particles (atoms and molecules) in a liquid can break away from each other and get attracted while approaching the other molecules. Like in solids,

the intermolecular forces become repulsive when an attempt is made to bring the molecules closer by applying pressure. This is the reason why pressure does not have much effect on volume of liquids.

2.3.3 Gases

We cannot see gases but they are all around us. We can feel the presence of air when the wind blows. **The wind is moving air and is a mixture of many gases like oxygen, nitrogen, argon, carbon dioxide and others.** A gas occupies the entire volume of the container irrespective of its size (see Figure 2.1). In gases, molecules move freely because the intermolecular forces are very weak and are unable to keep the gas molecules together in bulk. The molecules remain far apart from each other due to weak molecular interactions. Since molecules are far away from each other in gases, they can be brought closer when pressure is applied. This is the reason why-gases are highly compressible. We can compress a gas only up to a certain limit. Beyond this limit repulsion between gas molecules becomes very high. Temperature also affects the volume of the gases. When temperature increases, volume of the gas also increases. For example when a closed container is heated it blasts due to rapid increase in volume.

We are lucky that a gas can be compressed easily. If this was not the case then we could not have obtained CNG (Compressed Natural Gas). As you might be aware that CNG is used as a clean fuel for vehicles and you might have noticed that at the back of several Autorikshas and buses, CNG is written. We also have our cooking gas cylinders in kitchen because gas (LPG) is compressible. There are many other examples of uses based on compressibility of gases. Can you think some more examples? Oxygen cylinder in hospital is another example.

The distribution of molecules in solid, liquid and gas is shown in Fig 2.2.

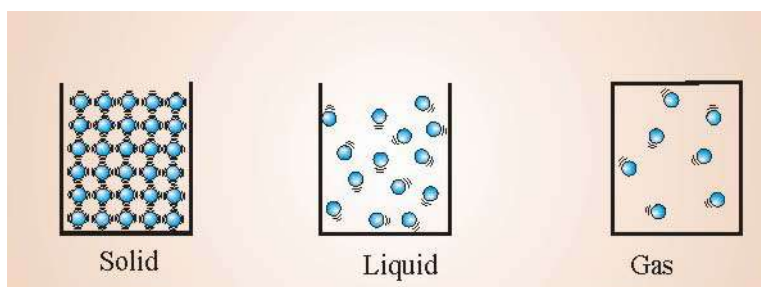

Fig. 2.2: Schematic representation of distribution of molecules in solid, liquid and gas



Notes



Notes

? Do you know

Three basic states of matter, described above, are dominant on Earth but they become less relevant in other parts of the universe. You will be surprised to know that 99% of the matter in the entire universe is not a solid, a liquid or a gas. The form of matter that is more dominant is called 'plasma'. The Sun consists of plasma as most of the other stars do. You will learn about "plasma" in your higher classes.

Different characteristics of the three states of matter have been summarized in Table.2.1.

Table 2.1 Different characteristics of the three states of matter

State of matter	Volume	Density	Shape	Fluidity	Compressibility
Solid	Has fixed volume	High	Has definite shape	Does not flow	Negligible
Liquid	Has fixed volume	Lower as compared to solid	Has no definite shape. It takes the shape of container.	Flows smoothly	Very small
Gas	Has no fixed volume	Low	Has no definite shape.	Flows smoothly	Highly compressible



INTEXT QUESTIONS 2.2

- Which of the three states of matter has no definite volume? Give one reason for your answer.
(a) Solid, (b) liquid, (c) gas
- Why do solids have definite shape?
- Name a substance which exists naturally in all the three states.

? Do you know

There are two basic concepts in the physical world around which you can organize everything. These two basic concepts are matter and energy. Both matter and energy are related to each other by the formula $E = mc^2$. Here E is energy, m is mass and c is velocity of light. One of the greatest scientists of all times, Albert Einstein showed that matter can be transformed into energy, and energy can be transformed into matter. No doubt, transforming matter into energy is easy whereas transforming energy into matter is difficult.

2.4 EFFECT OF TEMPERATURE AND PRESSURE ON STATES OF MATTER

Have you ever thought what happens if a solid substance is heated? When heat is supplied to a solid, it expands. This expansion is very small. In fact after receiving thermal energy, particles (atom/molecules) vibrate more rapidly in their position and take up more space. If particles become more energetic on further heating they leave their fixed positions and the solid melts. Once a solid becomes liquid it can be poured into a container. As you learned earlier, a liquid takes the shape of the container in which it is poured. Particles in the liquid state are free to move.

Now let us see what happens when a liquid is heated. On receiving heat (thermal energy) a liquid is converted into a gas. This happens because the kinetic energy of the particles becomes so high that they can overcome the intermolecular force within the liquid. Therefore liquid is converted into gas (vapour).

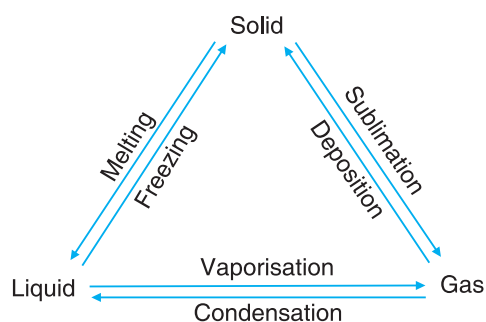

Fig. 2.3: Interconversion of states of matter

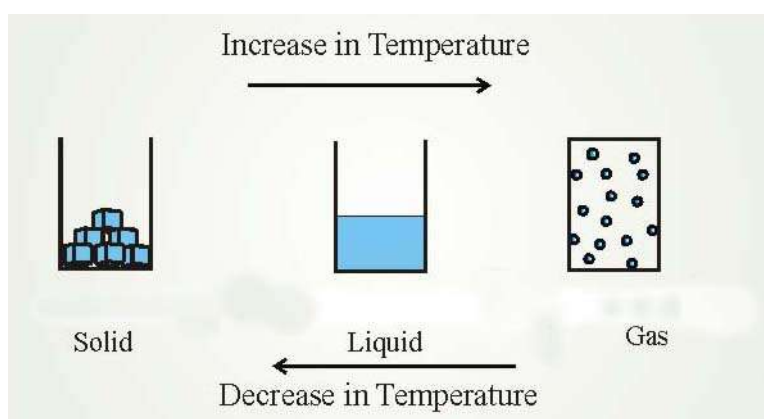

Fig. 2.4: Inter-conversion of states: from solid to liquid, liquid to gas and vice versa with variation of temperature



Notes



Notes

When a gas is heated, kinetic energy of the particles increases. They move more freely and at much higher speed. Intermolecular distance also increases and the volume of the gas increases if pressure is kept constant. Do you know what happens when a balloon filled with air is brought near fire?

A pure solid turns to liquid at a fixed temperature or in other words conversion of pure substance from solid to liquid takes place at one particular temperature. This particular temperature is called **melting point** of that particular solid substance. Similarly when the liquid cools down, it converts into solid at a particular temperature. This temperature is called **freezing point** of that particular liquid substance. The temperature at which a liquid boils and is converted into a gas is **boiling point** of the liquid.



ACTIVITY 2.1

Demonstrating the inter-conversion of the three states of matter

Materials required: Ice, container, gas burner or any other heating device.

How to do it:

Put the ice in the container and gradually heat it. First it will melt into water and if you continue heating it will turn into vapour.

You should remember that the three different states of matter respond differently with changes of temperature and pressure. All the three states expand or show an increase in volume when the temperature is increased. They contract or show a decrease in volume when the temperature is lowered. However, the effect of pressure on solid and liquid is negligible. A gas can be compressed easily by applying pressure.



ACTIVITY 2.2

You can observe the effect of pressure on gases and liquids by performing the following experiment.

Take a syringe and close its nozzle by inserting it in a rubber cork. Remove the piston so that the entire space inside the syringe is filled with air. Now, insert the piston carefully back in the syringe and try to compress the air by pushing the piston. What do you observe? You will find that the piston can be pushed easily. Of course beyond a point you will not be able to push the piston. This shows that air is compressible easily. Now you repeat the experiment with liquid. Can you push the piston as easily as you could push with air? If you try, you will find that it is not possible. This is because the molecules in liquids are much close to each other as compared to gases.

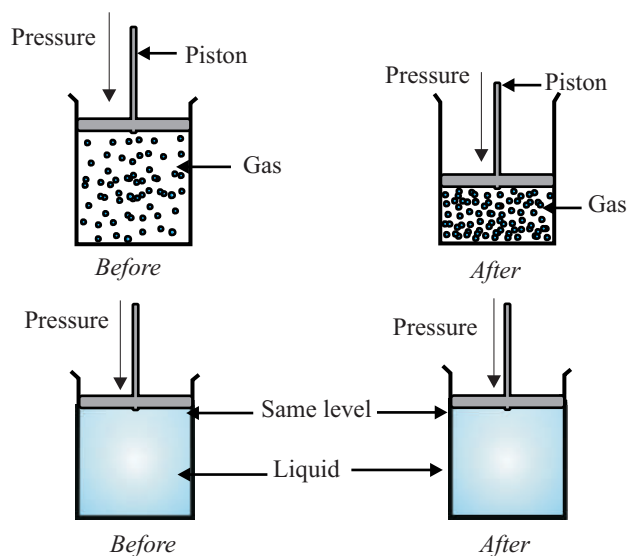

Fig. 2.5 : Effect of pressure on gas and liquid



Notes



INTEXT QUESTIONS 2.3

1. Why gases are more compressible as compared to solids?
2. How can you change water into ice?

2.5 ELEMENTS, COMPOUNDS AND MIXTURES

2.5.1 Elements

All substances are made up of chemical elements. A chemical element is a basic form of matter that cannot be chemically broken down into simpler substances. **A chemical element is a pure substance and it consists of one type of atom distinguished by its atomic number.** Examples of some elements are : helium, carbon, iron, gold, silver, copper, aluminum, hydrogen, oxygen, nitrogen, sulphur, copper, chlorine, iodine, uranium, and plutonium.

Elements are the building blocks of the Universe. In total, 114 elements have been listed so far. Out of the total 114 known elements, about 90 occur naturally on Earth and the remaining have been synthesized artificially by nuclear reactions. Only two elements namely hydrogen (92%) and helium (7%) make up about 99% of the total mass of the Universe. The remaining elements contribute only 1% to the total mass of the Universe.

Out of about 90 elements found naturally on Earth, two elements silicon and oxygen together make up almost three-quarters of the Earth's crust. Our body is also composed of elements but the composition of elements in human body is very much different from that of the Earth's crust, as it can be seen from Table 2.2.



Notes

Table 2.2: Elements in Earth’s crust and human body

Elements	% by mass	
	Earth’s Crust	Human Body
1. Aluminium	6.5	very little
2. Calcium	3.6	1.5
3. Carbon	0.03	18.5
4. Hydrogen	0.14	9.5
5. Iron	5.0	very little
6. Magnesium	2.1	0.1
7. Oxygen	46.6	65.0
8. Silicon	27.7	very little
9. Sodium	2.8	0.2
10. Sulphur	0.03	0.3

Although human beings and Earth share elements in their composition, human beings have several advantages like being able to think, feel etc. Don’t you think that it is our responsibility to take care of Earth?

2.5.2 Compounds

A compound is a substance formed when two or more than two elements are chemically combined. **A compound can be defined as a pure substance made from two or more elements chemically combined together in a definite proportion by mass.** When elements join to form compounds they lose their individual properties. Compounds have different properties from the elements they are made of. For example, water (a compound) is made up of elements – hydrogen and oxygen but properties of water are different from those of hydrogen and oxygen. The world of compounds is really fascinating because compounds show a great variety in forms and properties.

Some examples of compounds are given below:

Glucose	Glycerol	Calcium oxide
Sodium chloride	Sulphuric acid	Carbon dioxide
Hydrochloric acid	Chloroform	Acetic acid
Sodium carbonate	Ethanol	Carbon monoxide
Phenol	Citric acid	Methane

A pictorial representation of element compound and mixture is shown in Fig. 2.6



Notes

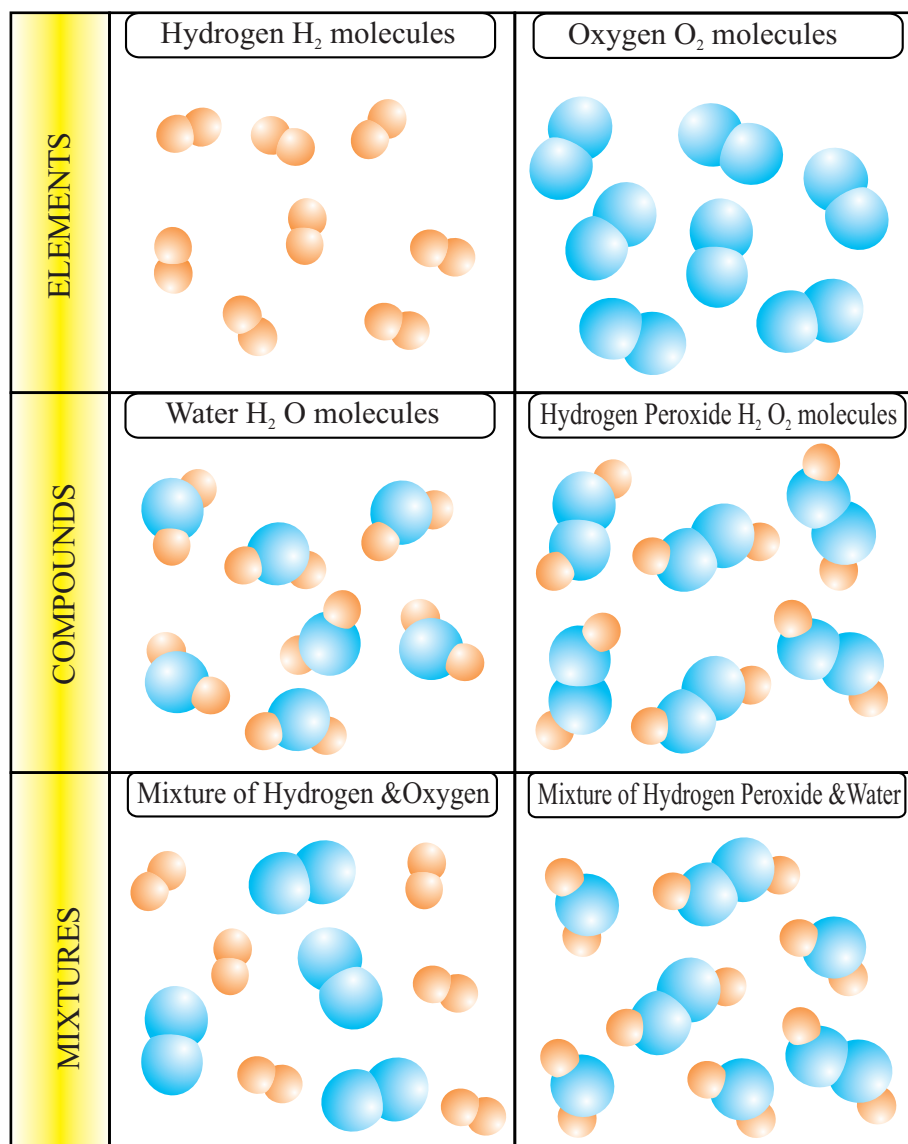

Fig. 2.6: A Pictorial representation of elements, compounds and mixtures. From the figure we can see that elements combine to form compounds but in the mixture the elements and compounds maintain their separate identities

2.5.3 Mixture

In our everyday life we deal with a large number of substances but majority of them are not pure substances (elements or compounds). They are mixtures of two or more pure substances. In the next section we shall see that there are two types of mixture depending on whether the parts of the mixtures completely mix or not

The relationship among elements, compounds and other categories of matter are summarized in Fig. 2.7.



Notes

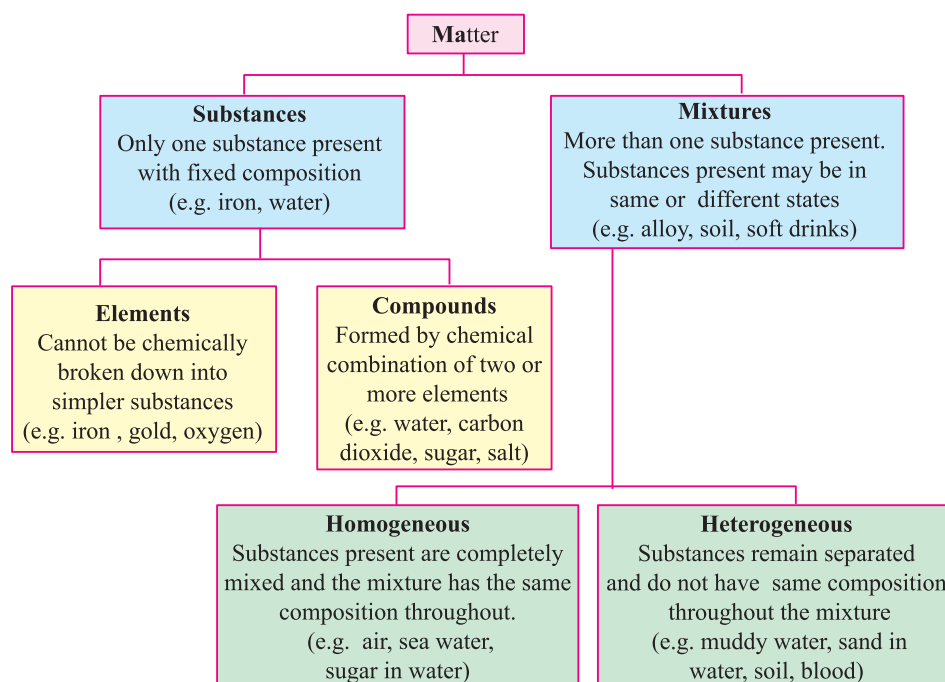

Fig. 2.7: Classification of matter



INTEXT QUESTIONS 2.4

1. Classify the following into element, compound and mixture:
aluminum, carbon, granite, water, silicon, carbon dioxide, air and sugar.
2. How does an element differ from a compound?
3. Which is the most abundant element in the universe?

2.6 HOMOGENEOUS AND HETEROGENEOUS MIXTURES

Mixtures are broadly divided in two major groups – (i) homogeneous mixtures and (ii) heterogeneous mixtures.

2.6.1 Homogeneous Mixture

You have seen that people having loose motion take ORS. What is ORS? You can yourself prepare ORS by putting little amounts of salt and sugar in water. ORS is an example of a homogeneous mixture or solution. So let us learn about homogeneous mixtures.

In some mixtures, constituents are completely mixed in such a way that the entire mixture has the same composition throughout. Such mixtures which have uniform composition are called **homogeneous mixtures**. For example when you prepare *sharbat* by mixing sugar and water in a jug, the entire mixture has the uniform

sweetness. Technically such homogeneous mixtures are called **solutions**. For example common salt, which is solid when dissolved in water, forms a liquid mixture or a salt solution. The salt is totally dispersed into water uniformly and one cannot see it (Fig. 2.8). Two-thirds of the Earth's surface is covered by sea water which is nothing but a homogeneous mixture (solution) of various salts in water. Sea water also contains dissolved gases like oxygen and carbon dioxide. The air we breathe is a homogenous mixture of different gases. Two liquids can also form homogeneous mixture for example water mixes with ethyl alcohol in all proportions. In other words water is miscible with ethyl alcohol or vice versa. Many alloys are also homogeneous mixtures of two or more than two metals. Gold and copper form homogeneous solid *solution*. Do you know a goldsmith can judge the purity of gold by testing any part of it.

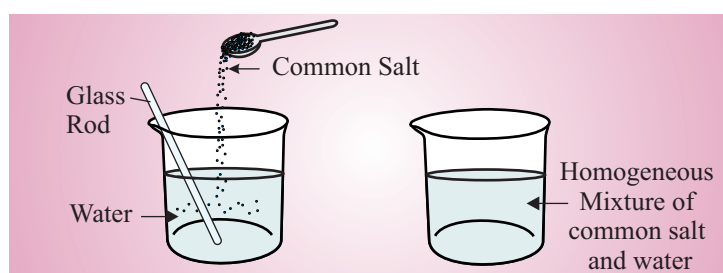

Fig. 2.8 Mixing of common salt into water

A homogeneous mixture is a mixture where the substances are completely mixed together and have uniform composition throughout.

Different types of homogeneous mixtures that may result by mixing different substances have been summarized in **Table 2.3**.

Table 2.3: Different types of homogeneous mixtures

Type of mixture	Description	Examples	Can you think another example(s)?
Solid + liquid	solid dissolves in liquid to form transparent solution	sugar in water or salt in water, iodine in ethyl alcohol (tincture iodine)	
Liquid + liquid	forms a single transparent mixture	Mixture of water and ethyl alcohol.	
Gas + liquid	Gas completely dissolves in a liquid to form a transparent solution	Soda water and any other common soft drink	
Gas + gas	mixture of two or more gases	Air	
Solid + solid	some metallic alloys	Brass, bronze	

You can discuss with your friends and others while carrying out the above exercise.



Notes



Notes

2.6.2 Heterogeneous Mixture

Have you ever brought a ‘mixture’ from market? If yes, then you must have noticed that such a mixture contains different constituents and each of these constituents is visible.

Such mixtures where the constituents do not completely mix with each other, and remain separate, are called *heterogeneous mixtures* (Fig. 2.9). In such mixtures one substance is spread throughout the other in the form of small particles, droplets or bubbles.

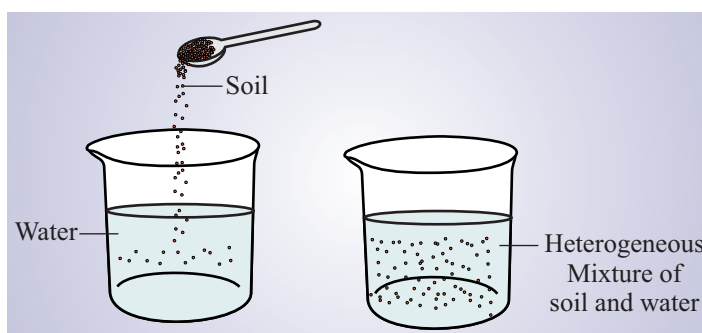

Fig. 2.9 Mixing of soil into water to form heterogeneous solution

A heterogeneous mixture is a mixture where the substances (parts or phases) remain separate and composition is not uniform.

Different types of heterogeneous mixtures that may result by mixing different substances have been summarized in **Table 2.4**.

Table 2.4: Different types of heterogeneous mixtures

Type of mixture	Description	Examples	Can you think of another example(s)?
Suspension	solid + liquid	flour in water, river water carrying mud	
Gel	liquid trapped in solid	fruit jelly, agar gel	
Emulsion	mixture of tiny droplets of one liquid suspended in another	milk	
Aerosol	small droplets of liquid or particles of solid dispersed in a gas	clouds (liquid in gas) smoke (solid in gas)	
Foam	Gas in liquid: small bubbles of gas trapped in liquid Gas in solid: small bubbles of gas trapped in solid	shaving foam polystyrene foam (Thermocoal)	

You may like to discuss with your mother to know whether any of the above types of mixtures are used in your home.



ACTIVITY 2.3

Collect at least 10 different things from your homes and surroundings and classify them based on their composition and place in the following table:

S.No.	Name of the things/ objects/ material	Element	Compound	Mixture	not known
				Homogeneous or Heterogeneous	
1.	Water				
2.					
3.					
4.					
5.					
6.					
7.					
8.					
9.					
10.					



INTEXT QUESTIONS 2.5

- Say whether ethyl alcohol and water form a homogeneous mixture or heterogeneous mixture.
- Give an example of homogeneous mixture obtained by mixing two solids.

2.7 SOLUTION AND ITS CONCENTRATION

A solution (a homogeneous mixture) is formed when one or more substances (the **solute**) are completely dissolved in another substance (the **solvent**). When we think about solutions, the most common examples that come to our mind are the solutions that are obtained by dissolving solids in water. Sugar or common salt dissolved in



Notes



Notes

water gives this type of solution. Do you know that two-third of the Earth's surface is covered by a solution? You may be able to guess this solution present in oceans. The sea-water is a solution of water and soluble minerals. It also contains gases like oxygen, nitrogen and carbon dioxide. Such dissolved gases are very important for aquatic life to survive in oceans.

There are some solutions of two or more than two liquids. As you know that ethyl alcohol mixes with water in all proportions to form a solution. Iodine (solid) dissolved in ethyl alcohol gives tincture of iodine which has antiseptic properties.

A solution made of solid dissolved in a liquid has two parts:

- the solid that dissolves is called the **solute**,
- the liquid, in which the solid is dissolved, is called the **solvent**. Fig. 2.10.

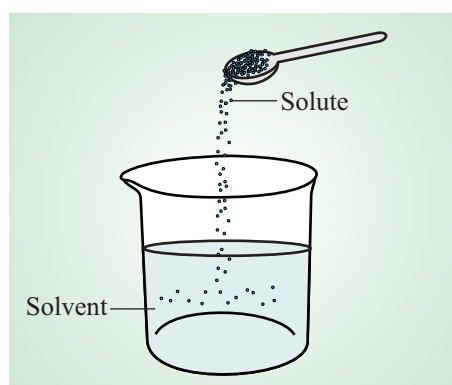

Fig. 2.10 Mixing of NaCl into water

You have just seen that solutions are not confined to only solids dissolved in liquids. There are other types of solutions as described earlier. In each case the **substance which is present in bigger quantity is normally taken as solvent and substance which is present in smaller quantity is normally taken as solute**.

When a substance dissolves in a solvent it is said that that particular solute is **soluble** in that particular solvent. If it does not dissolve then it is **insoluble**. Water is a commonly used solvent as it dissolves a large number of substances. Because of this property water is called a **universal solvent**. Different types of substances dissolve in water. Because of this unique property of water, plants can take minerals from the soil? Being a good solvent, water is used in many ways. However, there are some disadvantages also which result from this unique property of water. Water becomes easily contaminated. Therefore, purifying water for drinking and other uses is a major challenge.

There are other important solvents, for examples organic liquids. The **organic solvents** are important because, unlike water, they dissolve organic substances. Ethyl alcohol and benzene are examples of such organic solvents.

2.7.1 Concentration of a Solution

The term “concentration” is most often used when we talk about solutions. Concentration of a solution is expressed in terms of the amount of solute present in a given mass or in a given volume of a solvent. Usually **concentration** of a solution is defined as the mass of solute present in a definite volume of a **solution** (which is usually taken as 1 litre). Concentration of a solution may also be expressed in terms of per cent by mass of solute (in gram). This gives the mass of solute per 100 mass units (grams) of solution as shown below:

$$\% \text{ of solute} = (\text{mass of solute} / \text{mass of solution}) \times 100.$$

A solution of 10% glucose by mass means that 100 grams of the solution contains 10 gram of glucose. This means 10 grams of glucose is dissolved in 90 grams of water.

When we try to dissolve a particular substance say sugar in water, the solution becomes more concentrated as we add more and more sugar. A concentrated solution contains a high proportion of the solute. A dilute solution contains a small proportion of solute.

If we keep on adding solute to a solvent, keeping the temperature constant we reach a point where no more solute will be dissolved. At this point we say that the solution has become **saturated** with respect to solute. However, if we increase the temperature, more solute will get dissolved. **The concentration of a solute in a saturated solution at a definite temperature is called solubility of that solute in that particular solvent.**



ACTIVITY 2.4

Make a solution of sodium chloride in water with a known concentration of 10g/litre by mass.

1. Take a graduated flask and fill approximately half with distilled water (the solvent).
2. Weigh out 10 g of sodium chloride (the solute).
3. Carefully add the sodium chloride to the water in the container.
4. Gently shake the container to dissolve all the sodium chloride.
5. Add more distilled water to make up the volume of the solution to exactly the 1000 mL (1.0 dm³) mark on the neck of the graduated flask. Finally shake the flask carefully to make the solution uniform.



Notes



Notes



INTEXT QUESTIONS 2.6

1. To make one kilogram of 40% sugar solution by mass, how much sugar and water will you need?
sugar
water
2. What is the name given to a liquid which dissolves a solid to make a solution?
3. To make a given solution more concentrated, what will you add?

2.8 SUSPENSIONS

In winter, the fog is a common experience in both urban and rural areas. What is fog? Fog forms when tiny water droplets are suspended in air. So fog is nothing but a type of a suspension. There are large numbers of substances which do not mix with each other. There are some solids that do not dissolve in water or other liquid solvents and there are liquids that do not mix with each other. The mixing of such substances results into heterogeneous mixtures. Depending on the size of the particles suspended, or dispersed in the surrounding medium, heterogeneous mixtures can be divided into colloids and suspension. You will study about colloids in higher classes. Here we shall briefly describe suspension. Materials of smaller particle size, insoluble in a solvent but visible to naked eyes, form suspension.

Unlike a colloid, which contains smaller particles ranging in size from 1 to 1000 nanometres, a suspension contains relatively larger particles. The size of particles in suspension is over 1000 nanometres. When flour is added to water it does not dissolve but forms a slurry, which we call a suspension. However, if less amount of water is added in the flour (200 g of flour and 100 mL of water) we get dough to make chapatti etc. Muddy water is an example of suspension. When a suspension is allowed to stand undisturbed, the dispersed particles settle down (Fig. 2.11).

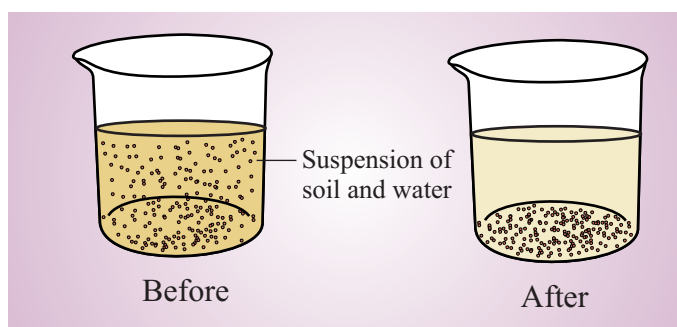

Fig. 2.11 Settling of suspension when it is allowed to stand undisturbed

Suspensions are very useful in medical sciences. For example barium sulphate (whose solubility is very low when dispersed in water) is an opaque medium. It is used for diagnostic X-rays (barium meal test). Many medicines, which are insoluble in water, are given in the form of suspension, for example, penicillin and amoxicillin. Please check a few bottles of medicine. Do you find the word suspension written on a bottle.



ACTIVITY 2.5

Prepare a suspension using materials available in your home.

Materials required: Wheat flour (1 cup approximate 200g), water, a glass (250 mL), and a spoon.

How to do it

Pour water into a glass and add wheat flour to water. Stir the water with the help of the spoon. Keep the mixture undisturbed for some time. Write your observation and identify whether you have prepared a suspension or a solution. Give at least one reason for your answer..

2.9 SEPARATION OF MIXTURES

Have you seen someone removing unwanted materials from rice or wheat? If so then you have seen separation of heterogeneous mixture into pure components by physical means. Have you eaten *mishri*, the bigger crystal of sugar? Preparation of *mishri* involves separation of sugar from homogeneous mixture of sugar and water. Both in our households and in industries we need to separate mixtures, both homogeneous and heterogeneous, for various purposes. Fortunately we can recover sugar or salt from its water solution by evaporating the water or even sometimes by heating. To separate different components of a mixture variety of physical techniques are available. ***All these separation techniques are based on difference in the physical properties of the components present in the mixture.*** The following two factors decide the best possible technique to be adopted for separation:

- (i) the type of mixture,
- (ii) the component which you want to collect.

Here we shall describe some of the common techniques of separation.

2.9.1 Separation by using Separating Funnels

The mixture of two immiscible liquids (i.e, the liquids that do not mix, as oil and water) can be separated by using a **separating funnel**. The mixture is placed in



Notes



separating funnel and allowed to stand for some times. When the two layers of liquids are separated, the denser liquid which is in the lower part, is first collected by opening the stop-cock. (See Fig. 2.12) This method is very useful in industries.

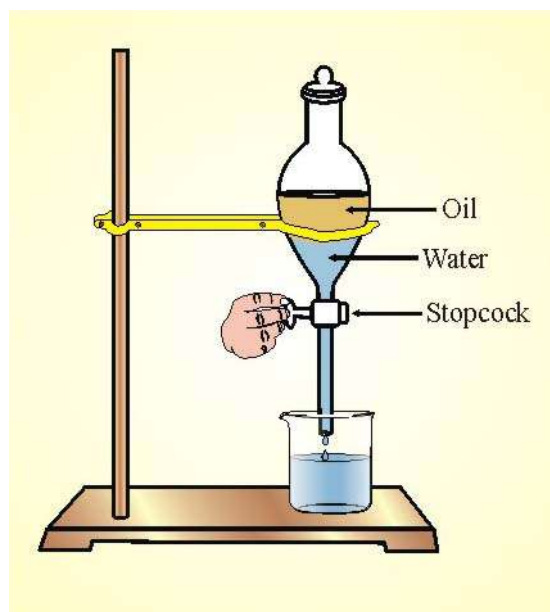

Fig. 2.12: Separation of oil and water using separating funnel

2.9.2 Separation by Evaporation

The separation of liquid (solvent) and solid (solute) from a solution is done by removing the liquid (solvent) by heating or by solar evaporation. By evaporation you can recover the solute component only in solid or powder form. If the solvent is inflammable you cannot use flame for heating instead you can use an electrical heating system and an oil or water bath. You might have heard that salt is obtained from sea water by the process of evaporation in shallow beds near the sea shore.

2.9.3 Separation by Filtration

Filtration is a better method for separating solids from liquids in heterogeneous mixtures. In filtration the solid material is collected as a residue on filter paper and the liquid phase is obtained as filtrate. The method of filtration is used on a large scale in industries Fig. 2.13.

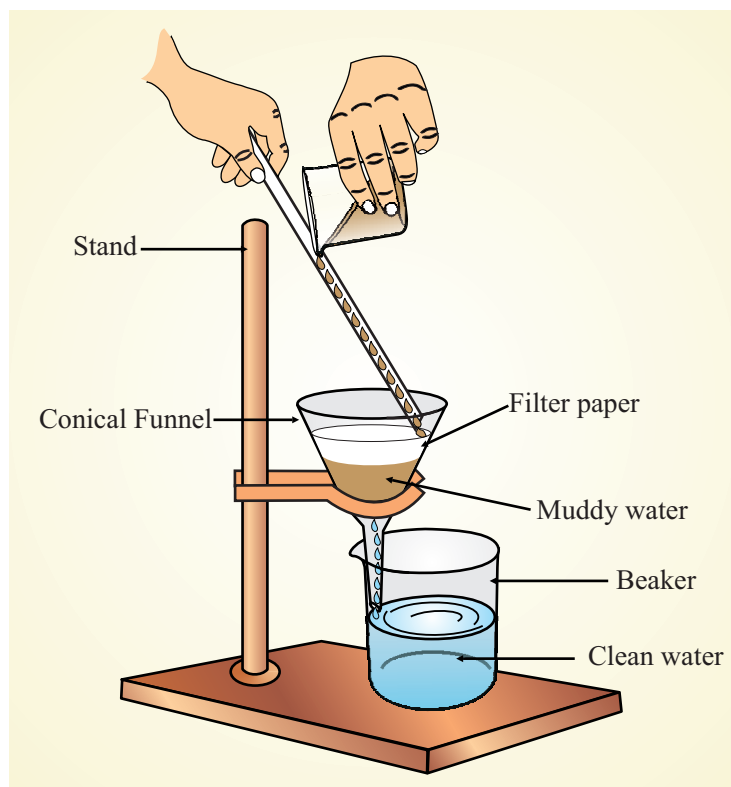

(a)

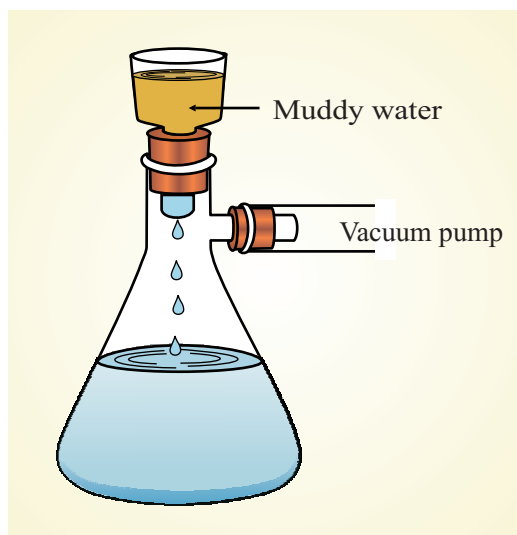

(b)

Fig. 2.13: Filtration (a) simple filtration (b) vacuum filtration

2.9.4 Separation by Crystallization

Crystallization is a process of formation of solid crystals from a solution. The method of crystallization for separating solid from liquid begins by evaporating the liquid.



Notes



Notes

However, in crystallization, the evaporation is stopped when the solution is concentrated enough. The concentrated solution thus produced, is allowed to cool slowly to form crystals which can be separated by filtration. *Mishri* (sugar crystals) is produced by crystallization from concentrated sugar solution.

2.9.5 Separation by Distillation

The method of distillation is used to separate a liquid from a solution of a homogeneous mixture. The distillation is a process in which a liquid or mixture of liquids is boiled in a distillation flask. The vapour is condensed by passing through a water-cooled tube called **condenser** and collected as liquid called **distillate** Fig. 2.14. In case of a solution of two miscible liquids (the liquids which can be mixed completely) the **separation is based on the fact that the liquids will have different boiling points** and there is a wide difference between the boiling points of the two liquids.

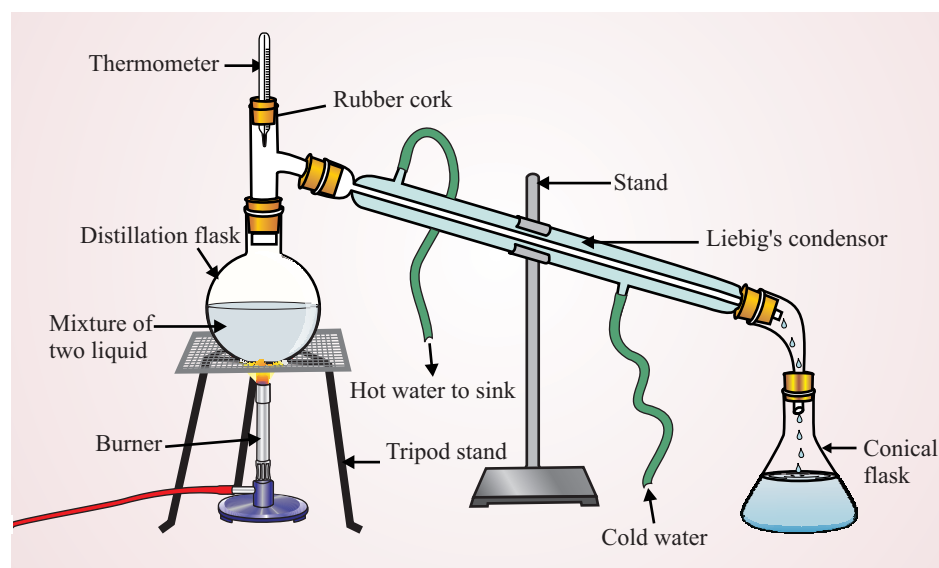

Fig. 2.14 : The Distillation apparatus

2.9.6 Separation based on Magnetic Properties

How would you separate a mixture of magnetic and non-magnetic substance? In a mixture of magnetic and non-magnetic substances, the magnetic substance can be separated by using a magnet. For example you will be able to separate iron granules, which are magnetic, from non-magnetic substances like sand, sugar, saw dust etc. (Fig. 2.15). In industry this method is used to separate iron materials from non-magnetic materials by using large electromagnets. e.g. of iron ore.

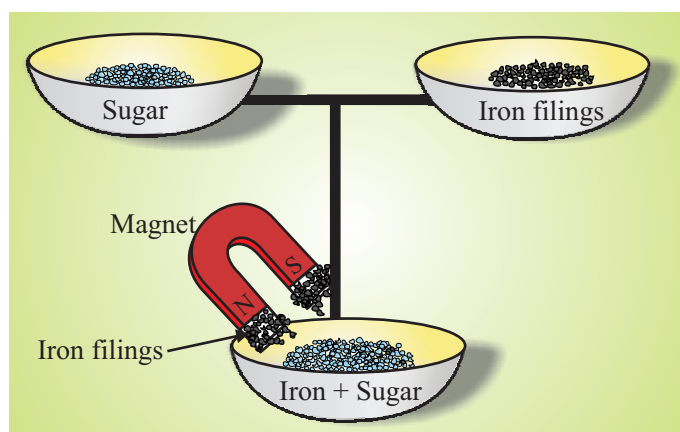

Fig. 2.15 : Magnetic Separation of a mixture



ACTIVITY 2.6

Separate iron granules from the mixture-iron granule and sugar.

Materials

Sugar, iron granules and a magnet.

How to do it

Mix the sugar crystals and iron granules and spread a thin layer of the mixture over a piece of paper. Hold the magnet closely over the mixture. The iron granules will be attracted to the magnet. Remove the iron granules from the magnet and repeat the process till no more iron granules remain in the mixture.



ACTIVITY 2.7

Separate water from muddy water by the process of distillation using solar energy

Materials

Large dish pan, a glass container shorter in length than the pan, plastic wrap, 9-10 clean marbles or small pieces of stone, plastic membrane, and (2 litre) muddy water.

How to do it

1. Take muddy water in a large pan and put a glass in the centre of the pan as shown in Fig. 2.16. Put a few small marbles at the bottoms of the glass in order to make it stable in the water.



Notes



- Cover the pan with a plastic wrap in such a way that it doesn't become too tight. The cello tape can be used to keep the plastic wrap in place.
- Put marble or a small piece of stone in the centre of the plastic wrap to create a slight dip in the plastic over the glass for collecting water. The plastic should not touch glass.
- Keep the pan in direct sunlight for several hours and you will see water vapour condense on the plastic and drip into the small glass container.

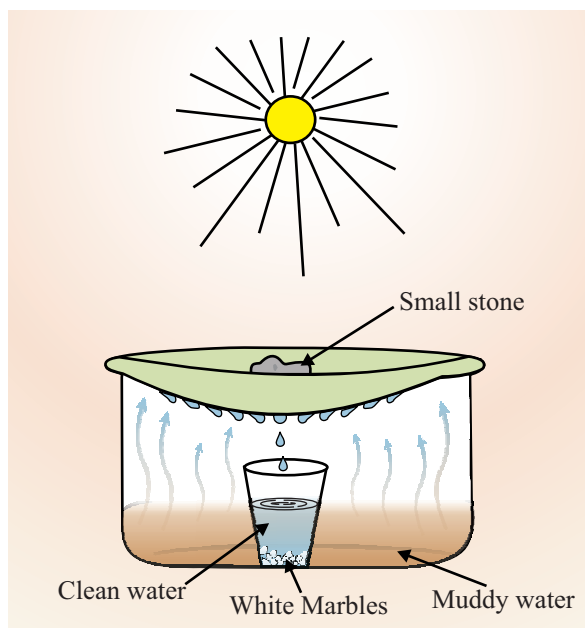

Fig. 2.16: Solar still for purifying water

The device prepared by following the steps mentioned above is called a **solar still** (see Fig. 2.16.), which uses the natural process of evaporation and condensation to purify muddy water. The muddy water kept in the pan gets heated by the sun. The water is turned into vapour, and the mud remains in the bottom of the pan. The vapour on touching the plastic sheet covering the pan gets condensed as the plastic sheet is relatively cool because of the cooler air outside the container. The water collected in the small container is clean water (but not very fit for drinking).



INTEXT QUESTIONS 2.7

- Which physical property is used to separate iron granules from dust particles?
 - Magnetic,
 - Electric,
 - Density
- The separation of sugar in the form of *Mishree* is called
 - evaporation
 - crystallization
 - distillation



WHAT YOU HAVE LEARNT

- Anything that has mass and occupies space is matter. Matter can be detected and measured.
- There are three different physical states of matter in which a substance can exist namely solid, liquid and gas.
- A particular state of matter can be changed into other states by changing the temperature and/or pressure.
- A solid has a definite size and shape which do not change on their own.
- A liquid has a definite size or volume and it takes shape of the container in which the liquid is kept.
- A gas has no shape or size of its own. It occupies entire volume of the container in which it is kept.
- Matter can be classified on the basis of its composition as element, compound or mixture.
- An element is a basic form of matter that cannot be chemically broken down into simpler substances.
- A compound is a pure substance made from two or more than two elements chemically combined together in a definite proportion by mass.
- Pressure and temperature affect states of matter.
- A wide varieties of mixture are possible between substances depending on their nature.
- A homogeneous mixture is a mixture where the substances are completely mixed together and are indistinguishable. A homogeneous mixture is called a solution.
- A heterogeneous mixture is a mixture where the substances remain separate and the composition is not uniform.
- A suspension is a heterogeneous mixture where the dispersed particles are large enough to settle out eventually.
- There are a number of methods available to purify and separate substances from a mixture. Some of the methods are filtration, crystallization and distillation.



TERMINAL EXERCISE

1. Indicate whether each of the following statements is true or false.
 - (i) A liquid has a definite shape true/false
 - (ii) An element cannot be broken into simpler substances by chemical means. true/false



Notes

MODULE - 2

Matter in our Surroundings



Notes

Matter in Our Surroundings

- (iii) A solid cannot be converted into liquid even by increasing temperature. true/false
- (iv) A liquid can be converted into solid by lowering temperature true/false
2. Indicate the normal state (i.e. state at room temperature) of each of the following?
- (i) iron (ii) water (iii) nitrogen
- (iv) carbon (v) gold (vi) oxygen
3. In the table given below, a list of substances has been provided. Identify whether each of them is an element, compound, mixture or solution.
- (i) Milk (ii) Sugar (iii) Silver
- (iv) Air (v) Water (vi) Sea water
- (vii) Iron (viii) Sugar (ix) Carbon dioxide
4. Why is it important to store cooking gas cylinder away from heat and flame?
5. Identify the most appropriate method to separate the following:

Substances

Method of Separation

1. Separate water from yogurt
2. Separate clean water from muddy water
3. Separate oil from oil water mixture
4. Separate iron nails from saw dust
5. Separate sugar from saturated sugar solution



ANSWERS OF THE INTEXT QUESTIONS

2.1

1. Matter is anything that has mass and occupies space
2. Soil
3. Democritus. The word atom means indivisible.

2.2

1. Gases. A gas has no definite volume because intermolecular forces in gas are so weak that the molecules are far apart and in constant motion. They can fill container of any size.
2. The molecules in solids have fixed positions and strong intermolecular forces are acting between them. Therefore, it solids have a definite shape.
3. Water

2.3

1. Molecules in solids are closely packed and any attempt to bring them closer results in strong repulsive forces and so solids cannot be compressed. In gases there are large spaces between their molecules and can be brought closer by applying pressure.
2. Water can be converted into ice by lowering the temperature.

2.4

- | | | |
|------------|----------------|---------|
| 1. Element | Compound | Mixture |
| Aluminium | Water | air |
| Carbon | Carbon dioxide | granite |
| Silicon | Sugar | |
2. An element consists of one type of atom but a compound contains two or more types of atom.
 3. Hydrogen

2.5

1. The mixture of ethyl alcohol and water is a homogeneous mixture
2. Alloys eg. brass

2.6

1. 400 g sugar and 600 g water
2. Solvent
3. Solute

2.7

1. Magnetic
2. Crystallisation



Notes



ATOMS AND MOLECULES

In the previous chapter you learnt about matter. The idea of divisibility of matter was considered long back in India around 500 B.C. Maharishi Kanad, an Indian Philosopher discussed it in his Darshan (Vaisesik Darshan). He said if we go on dividing matter, we shall get smaller and smaller particles. A stage would come beyond which further division will not be possible. He named these particles as 'PARMANU'. This concept was further elaborated by another Indian philosopher, Pakudha Katyayan. Katyayan said that these particles normally exist in a combined form which gives us various forms of matter.

Around the same era, an ancient Greek philosopher Democritus (460 – 370 BC) and Leucippus suggested that if we go on dividing matter, a stage will come when further division of particles will not be possible. Democritus called these individual particles 'atoms' (which means indivisible). These ideas were based on philosophical considerations. Experimental work to validate these ideas could not be done till the eighteenth century. However, today we know what an atom is and how it is responsible for different properties of substances. In this chapter, we shall study about atoms and molecules and related aspects like atomic and molecular masses, mole concept and molar masses. We shall also learn how to write chemical formula of a compound.



OBJECTIVES

After completing this lesson you will be able to :

- *state the law of conservation of mass and law of constant proportions;*
- *list important features of Dalton's atomic theory;*
- *distinguish between atoms and molecules;*
- *define isotopic mass, atomic mass, and molecular mass;*

- define the mole concept and molar mass;
- represent some molecules with the help of a formula;
- apply the mole concept to chemical reaction and show a quantitative relationship between masses of reactants and products and
- solve simple problems based on various concepts learnt.



Notes

3.1 LAWS OF CHEMICAL COMBINATIONS

There was tremendous progress in Chemical Sciences after 18th century. It arose out of an interest in the nature of heat and the way things burn. Major progress was made through the careful use of *chemical balance* to determine the change in mass that occurs in chemical reactions. The great French Chemist Antoine Lavoisier used the balance to study chemical reactions. He heated mercury in a sealed flask that contained air. After several days, a red substance mercury (II) oxide was produced. The gas remaining in the flask was reduced in mass. The remaining gas was neither able to support combustion nor life. The remaining gas in the flask was identified as nitrogen. The gas which combined with mercury was oxygen. Further he carefully performed the experiment by taking a weighed quantity of mercury (II) oxide. After strong heating, he found that mercury (II) oxide, red in colour, was decomposed into mercury and oxygen. He weighed both mercury and oxygen and found that their combined mass was equal to that of the mercury (II) oxide taken. Lavoisier finally came to the conclusion that *in every chemical reaction, total masses of all the reactants is equal to the masses of all the products*. This law is known as the **law of conservation of mass**.

There was rapid progress in science after chemists began accurate determination of masses of reactants and products. French chemist Claude Berthollet and Joseph Proust worked on the ratio (by mass) of two elements which combine to form a compound. Through a careful work, Proust demonstrated the fundamental law of definite or constant proportions in 1808. **In a given chemical compound, the proportions by mass of the elements that compose it are fixed, independent of the origin of the compound or its mode of preparation.**

In pure water, for instance, the ratio of mass of hydrogen to the mass of oxygen is always 1:8 irrespective of the source of water. In other words, pure water contains 11.11% of hydrogen and 88.89% of oxygen by mass whether water is obtained from well, river or from a pond. Thus, if 9.0 g of water are decomposed, 1.0 g of hydrogen and 8.0 g of oxygen are always obtained. Furthermore, if 3.0 g of hydrogen are mixed with 8.0 g of oxygen and the mixture is ignited, 9.0 g of water are formed and 2.0 g of hydrogen remains unreacted. Similarly sodium chloride contains 60.66% of chlorine and 39.34% of sodium by mass whether we obtained it from salt mines or



Notes

by crystallising it from water of ocean or inland salt seas or synthesizing it from its elements sodium and chlorine. Of course, the key word in this sentence is 'pure'. Reproducible experimental results are highlights of scientific thoughts. In fact modern science is based on experimental findings. **Reproducible results indirectly hint for a truth which is hidden.** Scientists always worked for findings this truth and in this manner many theories and laws were discovered. This search for truth plays an important role in the development of science.

3.2 DALTON'S ATOMIC THEORY

The English scientist John Dalton was by no means the first person to propose the existence of atoms, as we have seen in the previous section, such ideas date back to classical times. Dalton's major contribution was to arrange those ideas in proper order and give evidence for the existence of atoms. He showed that the mass relationship expressed by Lavoisier and Proust (in the form of law of conservation of mass and law of constant proportions) could be interpreted most suitably by postulating the existence of atoms of the various elements.

In 1803, Dalton published a new system of chemical philosophy in which the following statements comprise the atomic theory of matter:

1. Matter consists of indivisible atoms.
2. All the atoms of a given chemical element are identical in mass and in all other properties.
3. Different chemical elements have different kinds of atoms and in particular such atoms have different masses.
4. Atoms are indestructible and retain their identity in chemical reactions.
5. The formation of a compound from its elements occurs through the combination of atoms of unlike elements in small whole number ratio.

Dalton's fourth postulate is clearly related to the law of conservation of mass. Every atom of an element has a definite mass. Also in a chemical reaction there is rearrangement of atoms. Therefore after the reaction, mass of the product should remain the same. The fifth postulate is an attempt to explain the law of definite proportions. A compound is a type of matter containing the atoms of two or more elements in small whole number ratio. Because the atoms have definite mass, the compound must have the elements in definite proportions by mass.



John Dalton (1766-1844)

Fig. 3.1



Notes

The Dalton's atomic theory not only explained the laws of conservations of mass and law of constant proportions but also predicted the new ones. He deduced **the law of multiple proportions** on the basis of his theory. The law states that **when two elements form more than one compound, the masses of one element in these compound for a fixed mass of the other element are in the ratio of small whole numbers**. For example, carbon and oxygen form two compounds: Carbon monoxide and carbon dioxide. Carbon monoxide contains 1.3321 g of oxygen for each 1.000g of carbon, whereas carbon dioxide contains 2.6642 g of oxygen for 1.0000 g of carbon. In other words, carbon dioxide contains twice the mass of oxygen as is contained in carbon monoxide ($2.6642 \text{ g} = 2 \times 1.3321 \text{ g}$) for a given mass of carbon. Atomic theory explains this by saying that carbon dioxide contains twice as many oxygen atoms for a given number of carbon atoms as does carbon monoxide. The deduction of *law of multiple proportions* from atomic theory was important in convincing chemists of the validity of the theory.

3.2.1 What is an Atom?

As you have just seen in the previous section that an atom is the smallest particle of an element that retains its (elements) chemical properties. An atom of one element is different in size and mass from the atoms of the other elements. These atoms were considered 'indivisible' by Indian and Greek 'Philosophers' in the beginning and the name 'atom' as mentioned earlier, emerged out of this basic philosophy. Today, we know that atoms are not indivisible. They can be broken down into still smaller particles although they lose their chemical identity in this process. But inspite of all these developments atom still remains a **building block** of matter.

3.2.2 What is the size of the atom?

Atoms are very small, they are smaller than anything that we can imagine or compare with. In order to have a feeling of size of an atom you can consider this example: **One teaspoon of water (about 1 mL) contains about three times as many atoms as Atlantic ocean contains teaspoons of water**. Also more than millions of atoms when stacked would make a layer barely as thick as this sheet of paper. Atoms of different elements not only differ in mass as proposed by Dalton but also they differ in size. Now question is why should we bother for the size, mass and other properties of an atom? The reason is simple, every matter we see around us is made of atoms. Is it rectangular, circular or spherical? It is difficult to imagine the real shape of an atom but for all practical purposes it is taken as spherical in size and that is why we talk of its radius. Since size is extremely small and invisible to our eyes, we adopt a scale of nanometer ($1 \text{ nm} = 10^{-9} \text{ m}$) to express its size.

You can have a feeling of its size from the following table (Table 3.1).

Table 3.1 : Relative sizes

Radius (in m)	Example
10^{-10}	Atoms of hydrogen
10^{-4}	Grain of sand
10^{-1}	Water melon
0.2×10^{-1}	Cricket ball

You can not see atoms with your naked eyes but by using modern techniques, we can now produce magnified image of surface of elements showing atoms. The technique is known as Scanning Tunneling Microscopy (STM) (Fig. 3.2)

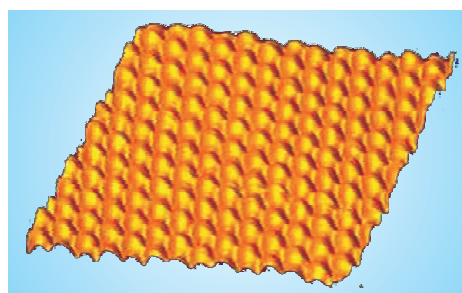

Fig. 3.2: Image of Copper surface by STM technique. Atom can be seen in magnified image of surface

3.2.3 Atomic Mass

Dalton gave the concept of atomic mass. According to him, atoms of the same element have same atomic masses but atoms of different elements have different atomic masses. Since Dalton could not weigh individual atoms, he measured relative masses of the elements required to form a compound. From this, he deduced **relative atomic masses**. For example, we can determine by experiment that 1.0000 g of hydrogen gas reacts with 7.9367 g of oxygen gas to form water. If we know formula of water, we can easily determine the mass of an oxygen atom relative to that of hydrogen atom.

Dalton did not have a way of determining the proportions of atoms of each element forming water during those days. He assumed the simplest possibility that atoms of oxygen and hydrogen were equal in number. From this assumption, it would follow that oxygen atom would have a mass that was 7.9367 times that of hydrogen atom. This in fact was not correct. We now know that in water number of hydrogen atoms is twice the number of oxygen atoms (formula of water being H_2O). Therefore, relative mass of oxygen atom must be $2 \times 7.9367 = 15.873$ times that of hydrogen atom. After Dalton, relative atomic masses of several elements were determined by scientists based on hydrogen scale. Later on, **hydrogen based scale** was replaced by a scale based on oxygen as it (oxygen) was more reactive and formed a large number of compounds.

In 1961, C-12 (or $^{12}_6C$) atomic mass scale was adopted. This scale depends on measurement of atomic mass by an instrument called **mass spectrometer**. Mass spectrometer invented early in 20th century, allows us to determine atomic masses



Notes

precisely. The masses of atoms are obtained by comparison with **C-12 atomic mass scale**. In fact C-12 isotope is chosen as standard and arbitrarily assigned a mass of exactly **12 atomic mass units**. One atomic mass unit (amu), therefore, equals exactly one twelfth of mass of a carbon-12 atom, Atomic mass unit (amu) is now-a-days is written as unified mass unit and is denoted by the letter 'u'.

The relative atomic mass of an element expressed in atomic mass unit is called its **atomic weight**. Now-a-days we are using **atomic mass** in place of atomic weight.

Further, you have seen that Dalton proposed that masses of all atoms in an element are equal. But later on it was found that all atoms of naturally occurring elements are not of the same mass. We shall study about such atoms in the following section. Atomic masses that we generally use in our reaction or in chemical calculations are **average atomic masses** which depend upon relative abundance of isotopes of elements.

3.2.4 Isotopes and Atomic Mass

Dalton considered an atom as an indivisible particle. Later researches proved that an atom consists of several fundamental particles such as : electrons, protons and neutrons. An electron is negatively charged and a proton is positively charged particle. Number of electrons and protons in an atom is equal. Since charge on an electron is equal and opposite to charge of a proton, therefore **an atom is electrically neutral**. Protons remain in the nucleus in the centre of the atom, and nucleus is surrounded by negatively charged electrons.

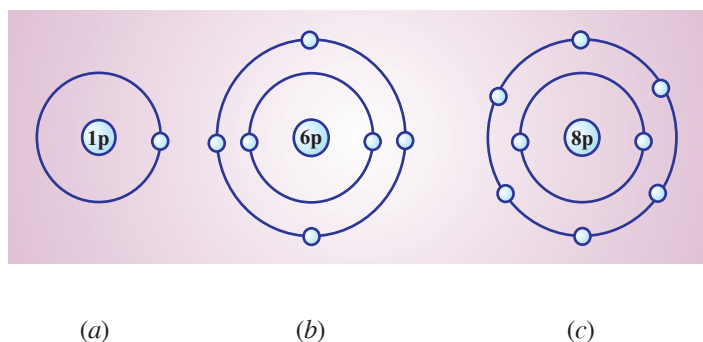

Fig. 3.3: Arrangement of electrons around nucleus in (a) hydrogen, (b) carbon and (c) oxygen atoms

The number of protons in the nucleus is called **atomic number** denoted by Z . For example in Fig. 3.3, there are 8 protons in the oxygen nucleus, 6 protons in carbon nucleus and only one proton in hydrogen nucleus. Therefore atomic numbers of oxygen, carbon and hydrogen are 8,6 and 1 respectively. There are also neutral



Notes



Notes

particles in the nucleus and they are called 'neutrons'. Mass of a proton and of a neutron is nearly the same.

Total mass of the nucleus = mass of protons + mass of neutrons

Total number of protons and neutrons is called **mass number (A)**. By convention atomic number is written at the bottom of left corner of the symbol of the atom of a particular element and mass number is written at the top left corner. For example, symbol ${}^{12}_6\text{C}$ indicates that there is a total of 12 particles (nucleons) in the nucleus of a carbon atom, 6 of which are protons. Thus, there must be $12 - 6 = 6$ neutrons. Similarly ${}^{16}_8\text{O}$ indicates 8 protons and 16 nucleons (8 protons + 8 neutrons). Since atom is electrically neutral, oxygen has 8 protons and 8 electrons in it. Further, atomic number (Z) differentiates the atom of one element from the atoms of the other elements.

An element may be defined as a substance where all the atoms have the same atomic number.

But the nuclei of all the atoms of a given element do not necessarily contain the same number of neutrons. For example, atoms of oxygen, found in nature, have the same number of protons which makes it different from other elements, but their neutrons (in nucleus) are different. This is the reason that the masses of atoms of the same element are different. For example, one type of oxygen atom contains 8 protons and 8 neutrons in one atom, second type 8 protons and 9 neutrons and the third type contains 8 protons and 10 neutrons. We represent these oxygen atoms as ${}^{16}_8\text{O}$, ${}^{17}_8\text{O}$ and ${}^{18}_8\text{O}$ respectively. **Atoms of an element that have the same atomic number (Z) but different mass number (A) are called isotopes.** In view of difference in atomic masses of the same element, we take average atomic masses of the elements. This is calculated on the basis of the *abundance of the isotopes*. Atomic masses of some elements are provided in Table 3.2.

Example 3.1 : Chlorine is obtained as a mixture of two isotopes ${}^{35}_{17}\text{Cl}$ and ${}^{37}_{17}\text{Cl}$. These isotopes are present in the ratio of 3:1. What will be the average atomic mass of chlorine?

Solution : ${}^{35}_{17}\text{Cl}$ and ${}^{37}_{17}\text{Cl}$ are present in the ratio of 3:1 i.e. out of four atoms, 3 atoms are of mass 35 and one atom of mass 37. Therefore,

$$\text{Average atomic mass} = \frac{35 \times 3 + 37 \times 1}{4} = \frac{142}{4} = 35.5 \text{ u}$$

Thus, average atomic mass of chlorine will be 35.5u.

Table 3.2 : Atomic mass* of some common elements

Elements	Symbol	Mass (u)	Elements	Symbol	Mass (u)
Aluminium	Al	26.93	Magnesium	Mg	24.31
Argon	Ar	39.95	Manganese	Mn	54.94
Arsenic	As	74.92	Mercury	Hg	200.59
Barium	Ba	137.34	Neon	Ne	20.18
Boron	B	10.81	Nickel	Ni	58.71
Bromine	Br	79.91	Nitrogen	N	14.01
Caesium	Cs	132.91	Oxygen	O	16.00
Calcium	Ca	40.08	Phosphorus	P	30.97
Carbon	C	12.01	Platinum	Pt	195.09
Chlorine	Cl	35.45	Potassium	K	39.1
Chromium	Cr	52.00	Radon	Rn	(222)**
Cobalt	Co	58.93	Silicon	Si	23.09
Copper	Cu	63.56	Silver	Ag	107.87
Fluorine	F	19.00	Sodium	Na	23.00
Gold	Au	196.97	Sulphur	S	32.06
Helium	He	4.00	Tin	Sn	118.69
Hydrogen	H	1.008	Titanium	Ti	47.88
Iodine	I	126.90	Tungsten	W	183.85
Iron	Fe	55.85	Uranium	U	238.03
Lead	Pb	207.19	Vanadium	V	50.94
Lithium	Li	6.94	Xenon	Xe	131.30
			Zinc	Zn	65.37

* Atomic masses are average atomic masses covered upto second decimal places. In practice, we use rounded figures.

** Radioactive



INTEXT QUESTIONS 3.1

- Name the scientists who proposed the law of conservation of mass and law of constant proportions.
- 12 g of magnesium powder was ignited in a container having 20 g of pure oxygen. After the reaction was over, it was found that 12 g of oxygen was left unreacted. Show that it is according to law of constant proportions.

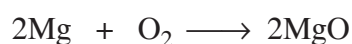

Notes



Notes

3.3 WHAT IS A MOLECULE?

Dalton proposed in his hypothesis that atoms react to form a molecule which he said as 'compound atoms'. Today we know what a molecule is. **A molecule is an aggregate of two or more than two atoms of the same or different elements in a definite arrangement.** These atoms are held together by chemical forces or *chemical bonds*. (You will study details of molecules in unit of chemical bonding) **An atom is the smallest particle of a substance but can not exist freely. Contrary to this, a molecules can be considered as the smallest particle of an element or of a compound which can exist alone or freely under ordinary conditions.** A molecule of a substance shows all chemical properties of that substance. To describe the chemical composition of a molecule we take the help of symbols of elements and formulas (described in sec 3.5). Oxygen molecule, with which we are familiar, is made of two atoms of oxygen and therefore it is a *diatomic molecule* (represented by O_2), hydrogen, nitrogen, fluorine, chlorine, bromine and iodine are other examples of diatomic molecules and are represented as H_2 , N_2 , F_2 , Cl_2 , Br_2 and I_2 respectively (Fig. 3.4).

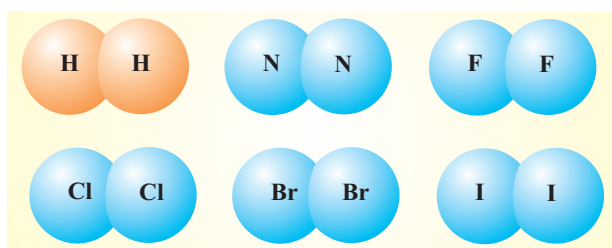
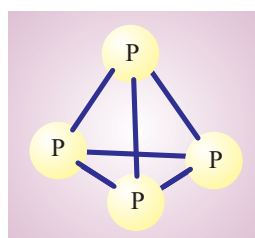
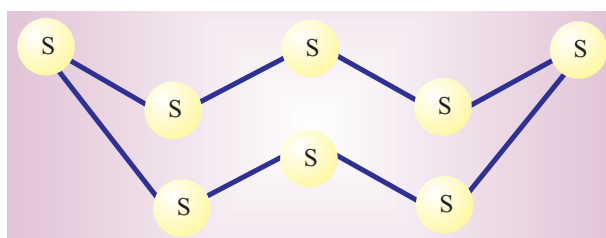

Fig. 3.4 : Representation of diatomic molecules

Some other elements exist as more complex molecules. Phosphorus molecule consists of four atoms (denoted by P_4) whereas sulphur exists as eight atom molecule (S_8) at ordinary temperature and pressure Fig. 3.5. A molecule made of four atoms is tetraatomic molecule. Normally, molecules consisting of more than three or four atoms are considered under the category of *polyatomic molecules*. Only a few years back, a form of carbon called buckminsterfullerene having molecular formula C_{60} was discovered which you will study later on in you higher classes.



Structure of phosphorus molecule P_4



Structure of a sulphur molecule S_8

Fig. 3.5 : Molecules of phosphorus and sulphur

Molecules of compounds are composed of more than one kind of atoms. A familiar example is a water molecule which is composed of more than one kind of atoms.

In one water molecule, there are two atoms of hydrogen and one atom of oxygen. It is represented as H_2O . A molecule of ammonia consists of one nitrogen atom and three hydrogen atoms. A molecule of ethyl alcohol (C_2H_5OH) is composed of nine atoms (2 atoms of carbon, 6 atoms of hydrogen and one atom of oxygen) Fig. 3.6.

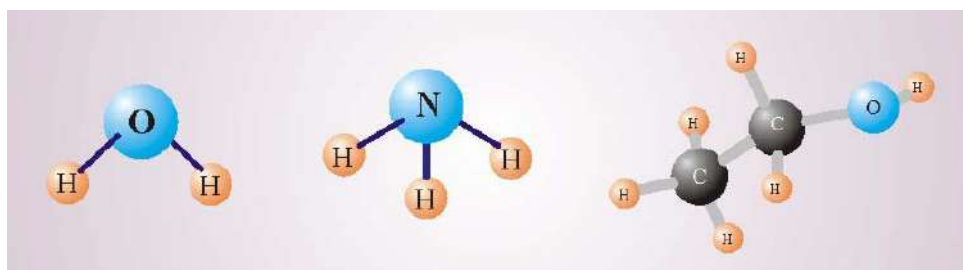

Molecule of water

Molecule of ammonia

Molecule of ethyl alcohol

Fig. 3.6 : Molecules of water, ammonia and ethyl alcohol

3.3.1 Molecular Mass

You have just read that a molecule can be represented in the form of a formula popularly known as **molecular formula**. Molecular formula may be of an element or of a compound. **Molecular formula of a compound is normally used for determining the molecular mass of that substance.** If a substance is composed of molecule (for example : CO_2 , H_2O or NH_3), it is easy to calculate the molecular mass. Molecular mass is the sum of atomic masses of all the atoms present in that molecule. Thus the **molecular mass is the sum of atomic masses of all the atoms present in that molecule.** The molecular mass of CO_2 is obtained as

$$\begin{array}{r} \text{C} \quad 1 \times 12.0 \text{ u} = 12.0 \text{ u} \\ 2 \text{ O} \quad 2 \times 16.0 \text{ u} = 32.0 \text{ u} \\ \hline \text{Mass of } CO_2 = 44.0 \text{ u} \end{array}$$

Hence, we write molecular mass of $CO_2 = 44.0 \text{ u}$

Similarly, we obtain molecular mass of NH_3 as follows:

$$\begin{array}{r} \text{N} \quad 1 \times 14.0 \text{ u} = 14.0 \text{ u} \\ 3 \text{ H} \quad 3 \times 1.08 \text{ u} = 3.24 \text{ u} \\ \hline \text{Mass of } NH_3 = 17.24 \text{ u} \end{array}$$

Molecular mass of ammonia, $NH_3 = 17.24 \text{ u}$

For substances which are not molecular in nature, we talk of **formula mass**. For example, sodium chloride (denoted by formula, $NaCl$) is an ionic substance. For this, we will calculate formula mass, similar to molecular mass. In case of sodium chloride, $NaCl$;

$$\begin{array}{r} \text{Formula mass} = \text{mass of 1 Na atom} + \text{mass of 1 Cl atom} \\ = 23 \text{ u} + 35.5 \text{ u} = 58.5 \text{ u} \end{array}$$

You will learn more about the molecular and ionic compounds in detail later.



Notes



Notes



INTEXT QUESTIONS 3.2

1. Nitrogen forms three oxides : NO, NO₂ and N₂O₃. Show that it obeys law of multiple proportions.
2. Atomic number of silicon is 14. If there are three isotopes of silicon having 14, 15 and 16 neutrons in their nuclei, what would be the symbol of the isotope?
3. Calculate molecular mass of the compounds whose formulas are provided below:
C₂H₄, H₂O and CH₃OH

3.4 MOLE CONCEPT

When we mix two substances, we get one or more new substances. For example, when we mix hydrogen and oxygen and ignite the mixture, we get a new substance-water. This can be represented in the form of a chemical equation,

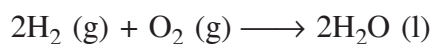

In the above equation, 2 molecules (four atoms) of hydrogen react with 1 molecule (2 atoms) of oxygen and give two molecules of water. We always like to know how many atoms/molecules of a particular substance would react with atoms/molecules of another substance in a chemical reaction. No matter how small they are. The solution to this problem is to have a convenient unit. Would you not like to have a convenient unit? Definitely a unit for counting of atoms/molecules present in a substance will be desirable and convenient as well. This chemical counting unit of atoms and molecules is called *mole*.

The word mole was, apparently introduced in about 1896 by Wilhelm Ostwald who derived the term from the Latin word ‘moles’ meaning a ‘heap’ or ‘pile’. The mole whose symbol is ‘mol’ is the SI (international system) base unit for measuring *amount of substance*. It is defined as follows:

A mole is the amount of substance that contains as many elementary entities (atoms, molecules, formula unit or other fundamental particles) as there are atoms in exactly 0.012 kg of carbon-12 isotope.

In simple words, mole is the number of atoms in exactly 0.012 kg (12 grams) of C-12. Although mole is defined in terms of carbon atoms but the unit is applicable to any substance just as 1 dozen means 12 or one gross means 144 of anything. Mole is scientist’s *counting unit* like dozen or gross. By using mole, scientists (particularly chemists) count atoms and molecules in a given substance. Now it is experimentally found that the number of atoms contained in exactly 12 g of C-12

is 602,200 000 000 000 000 000 000 or 6.022×10^{23} . This number is called *Avogadro's number* in honour of Amedeo Avogadro, an Italian lawyer and physicist. When this number is divided by 'mole' it becomes a constant and is known as *Avogadro's constant* denoted by symbol, $N_A = 6.02 \times 10^{23} \text{ mol}^{-1}$. We have seen that

$$\text{Atomic mass of C} = 12 \text{ u}$$

$$\text{Atomic mass of He} = 4 \text{ u}$$

We can see that one atom of carbon is three times as heavy as one atom of helium. On the same logic 100 atoms of carbon are three times as heavy as 100 atoms of helium. Similarly 6.02×10^{23} atoms of carbon are three times as heavy as 6.02×10^{23} atoms of helium. But 6.02×10^{23} atoms of carbon weigh 12 g, therefore 6.02×10^{23} atoms of helium will weigh $\frac{1}{3} \times 12 \text{ g} = 4 \text{ g}$. We can take a few more examples of elements and can calculate the mass of one mole atoms of that element.

3.4.1 Molar Mass

Mass of one mole of a substance is called its molar mass. A substance may be an element or a compound. Mass of one mole atoms of oxygen means mass of 6.02×10^{23} atoms of oxygen. It is found that one mole atoms of oxygen weighs 16.0 g. When we say one mole molecules of oxygen that means 6.02×10^{23} molecules of oxygen (O_2). One mole molecules of oxygen will weigh 32.0 g. Thus,

$$\text{Mass of one mole atoms of oxygen} = 16 \text{ g mol}^{-1}$$

$$\text{Mass of one mole molecules of oxygen} = 32 \text{ g mol}^{-1}$$

When it is not clear whether we are asking for one mole of atoms or one mole of molecules then we take natural form of that substance. For example, one mole of oxygen means one mole of oxygen molecules as oxygen occurs in the form of molecules in nature. In case of compounds, the same logic is applicable. For example, one mole of water means one mole molecules of water which weighs 18 g. Numerically one mole of a substance is equal to atomic or molecular mass of that substance expressed in grams.

Remember, molar mass is always expressed in the unit of g/mol or g mol^{-1} .

For example,

$$\text{Molar mass of nitrogen (N}_2\text{)} = 28 \text{ g mol}^{-1}$$

$$\text{Molar mass of chlorine (Cl}_2\text{)} = 71 \text{ g mol}^{-1}$$

Table 2.3 Provides molecular and molar mass of a few common substances.



Notes



Notes

Table 3.3 : Molecular and molar masses

Formula	Molecular Mass (u)	Molar mass (g/mol)
O ₂ (oxygen)	32.0	32.0
Cl ₂ (chlorine)	71.0	71.0
P ₄ (phosphorus)	123.9	123.9
CH ₄ (methane)	16.00	16.0
NH ₃ (ammonia)	17.0	17.0
HCl (hydrochloric acid gas)	36.5	36.5
CO ₂ (carbon dioxide)	44.0	44.0
SO ₂ (sulphur dioxide)	64.0	64.0
C ₂ H ₅ OH (ethyl alcohol)	46.0	46.0
C ₆ H ₆ (benzene)	78.0	78.00

Example 3.2 : How many grams are there in 3.5 mol of oxygen?

Solution : For converting mole into mass in grams and vice-versa, we always need a relationship between mass and mole.

Molar mass of oxygen (O₂) = 32 g mol⁻¹

Therefore, number of grams of oxygen in 3.5 mol of it

$$= 3.5 \text{ mol of oxygen} \times 32.0 \text{ g mol}^{-1}$$

$$= 112.0 \text{ g of oxygen}$$

Example 3.3 : Find out number of molecules in 27 g of water.

Solution: Mole concept provides a relationship between number of particles and their mass. Thus it is possible to calculate the number of particles in a given mass.

$$\text{Number of mole of H}_2\text{O} = \frac{\text{Mass of water (H}_2\text{O)}}{\text{Molar mass of H}_2\text{O}}$$

$$= \frac{27\text{g}}{18 \text{ g mol}^{-1}} = \frac{3}{2} \text{ mol} = 1.5 \text{ mol}$$

Since 1 mol of water contains 6.02×10²³ molecules.

$$\text{Therefore, 1.5 mol of water contains} = 6.02 \times 10^{23} \text{ molecules mol}^{-1} \times 1.5 \text{ mol}$$

$$= 9.03 \times 10^{23} \text{ molecules of water}$$



INTEXT QUESTIONS 3.3

1. Work out a relationship between number of molecules and mole.
2. What is molecular mass? In what way it is different from the molar mass?
3. Consider the reaction

$$\text{C (s)} + \text{O}_2 \text{ (g)} \longrightarrow \text{CO}_2 \text{ (g)}$$
 18 g of carbon was burnt in oxygen. How many moles of CO_2 is produced?
4. What is the molar mass of NaCl ?

3.5 WRITING CHEMICAL FORMULA OF COMPOUNDS

As you are aware, a compound is made of two or more than two elements combined in a definite proportion by mass (law of constant proportions). Thus, the number of combining atoms in a compound is fixed. The elements are represented by their symbols (e.g. H for hydrogen, Na for sodium). Similarly a compound is also represented by a shorthand notation known as formula or **chemical formula**. The formula of a compound indicates **(i) elements constituting the compound and (ii) the number of each constituent element. In other word, the formula of a compound also represents its chemical composition.** The atoms of elements constituting a compound are indicated by their symbols and their number is indicated as a **subscript** on the right hand bottom of the symbol. For example, in the formula of water, H_2O , two atoms of hydrogen are indicated as subscript '2', while oxygen is shown without writing any subscript, which means that the number of oxygen atom is just one.

3.5.1 Valency and Formulation

Every element has a definite capacity to combine with other elements. **This combining capacity of an element is called its valency.** You will learn very soon that this combining capacity of elements depends on the electronic configuration of elements. Valencies of a few elements are given in Table 3.4.

Table 3.4 : Valency of elements

Elements	Symbol	Valency	Elements	Symbol	Valency
Hydrogen	H	1	Phosphorus	P	5
Oxygen	O	2	Sodium	Na	1
Carbon	C	4	Magnesium	Mg	2
Nitrogen	N	3	Calcium	Ca	2
Chlorine	Cl	1	Aluminium	Al	3
Bromine	Br	1	Iron	Fe	2
Iodine	I	1	Barium	Ba	2



Notes



Notes

Most of the simple compounds are made of two elements. Such compounds are called **binary compounds**. It is easy to write formula of such compounds. When a metal combines with a non-metal, the symbol of the metal-element is written on the left hand side and that of the non-metal element on right hand side. (If both are non-metal, we write more electronegative* element on the right hand side). In naming a compound, the first element is written as such and the name of the second element i.e. more electronegative element, changes its ending to 'ide'. For writing chemical formula, we have to write valencies as shown below and then cross over the valencies of the combining atoms. Formula of the compounds resulting from carbon and chlorine, hydrogen and oxygen, and hydrogen and chlorine can be written as follows:

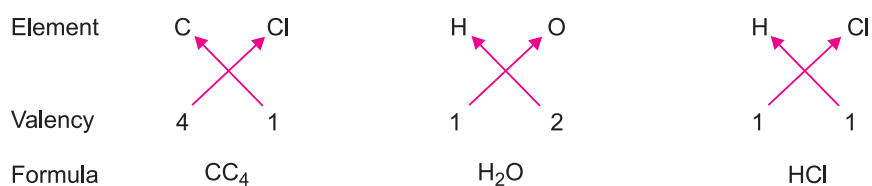

Some other examples for writing formula of compounds CaO, NaCl and NH₃ can also be taken for more clarity.

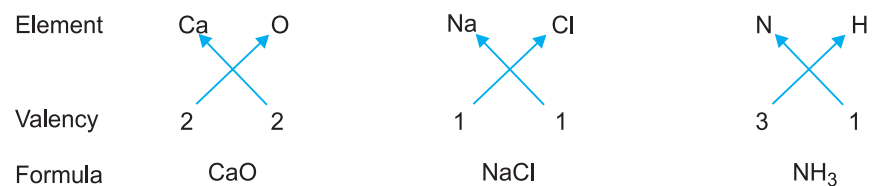

Thus, we can write formulas of various compounds if we know elements constituting them and their valencies.

Valency, as mentioned, depends on the electronic configuration and nature of the elements. Sometimes an element shows more than one type of valency. We say element has **variable valency**. For example nitrogen forms several oxides : N₂O, N₂O₂, N₂O₃, N₂O₄ and N₂O₅. If we take valency of oxygen equal to 2, then valency of nitrogen in the oxides will be 1,2,3,4 and 5 respectively. Valencies are not always fixed. Similar to nitrogen, phosphorus also shows valencies 3 and 5 as reflected in compounds PBr₃ and P₂O₅. In these compounds, there are more than one atom. In such cases, number of atoms is indicated by attaching a numerical prefix (mono, di, tri, etc) as mentioned in Table 2.5.

Table 3.5 : Numerical Prefixes

Number of atoms	Prefix	Example
1	Mono	carbon monoxide, CO
2	Di	carbon dioxide, CO ₂
3	Tri	phosphorus trichloride, PCl ₃
4	Tetra	carbon tetrachloride, CCl ₄
5	Penta	Dinitrogen pentoxide, N ₂ O ₅

Here you would notice that ‘-o’ or ‘-a’ at the end of the prefix is often dropped before another vowel, e.g. monoxide, pentoxide. There is no gap between numerical prefix and the name of the element. The prefix mono is usually dropped for the first element. When hydrogen is the first element in the formula, no prefix is added before hydrogen irrespective of the number. For example, the compound H_2S is named as hydrogen sulphide and not as dihydrogen sulphide.

Thus, we have seen that writing formula of a binary compound is relatively easy. However, when we have to write formula of a compound which involves more than two elements (i.e. of a polyatomic molecule), it is somewhat a cumbersome task. In the following section we shall consider formulation of more difficult compounds.

You will learn later on that there are basically two types of compounds: covalent compounds and ionic or electrovalent compounds. H_2O and NH_3 are covalent compounds. $NaCl$ and MgO are ionic compounds. An ionic compound is made of two charged constituents. One positively charged and other negatively charged. In case of $NaCl$, there are two ions : Na^+ and Cl^- ion. Charge of these ions in case of electrovalent compound is used for writing formula. It is easy to write formula of an ionic compound only if there is one metal and one non-metal as in the case of $NaCl$ and MgO . If there are more than two elements in an ionic compound, formulation will be a little difficult and in that situation we should know charge of cations and anions.

3.5.2 Formulation of Ionic compounds

Formulation of an ionic compound is easy when we know charge of cation and anion. Remember, in an ionic compound, sum of the charge of cation and anion should be equal to zero. A few examples of cations and anions with their charges are provided in Table 3.6.

Table 3.6 : Charges of some common cations and anions which form ionic compounds

Anions	Charge	Cations	Charge
Chloride ion, Cl^-	-1	Potassium ion, K^+	+1
Nitrate ion, NO_3^-	-1	Sodium ion, Na^+	+1
Hydroxide ion, OH^-	-1	Ammonium ion, NH_4^+	+1
Bicarbonate ion, HCO_3^-	-1	Magnesium ion, Mg^{2+}	+2
Nitrite ion, NO_2^-	-1	Calcium ion, Ca^{2+}	+2
Acetate ion, CH_3COO^-	-1	Lead ion, Pb^{2+}	+2
Bromide ion, Br^-	-1	Iron ion (ous), Fe^{2+}	+2
Iodide ion, I^-	-1	Zinc ion, Zn^{2+}	+2



Notes

MODULE - 2

Matter in our Surroundings



Notes

Atoms and Molecules

Sulphite ion, SO_3^{2-}	-2	Copper ion (cupric), Cu^{2+}	+2
Carbonate ion, CO_3^{2-}	-2	Mercury ion (Mercuric), Hg^{2+}	+2
Sulphate ion, SO_4^{2-}	-2	Iron (ic) ion, Fe^{3+}	+3
Sulphide ion, S^{2-}	-2	Aluminium ion, Al^{3+}	+3
Phosphate ion, PO_4^{3-}	-3	Potassium ion, K^+	+1
		Sodium ion, Na^+	+1

Suppose you have to write formula of sodium sulphate which is made of Na^+ and SO_4^{2-} ions. For this the positive and negative charge can be crossed over to give subscripts. The purpose of this crossing over of charges is to find the number of ions required to equate the number of positive and negative charges.

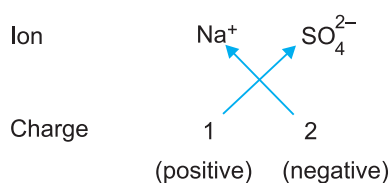

This gives the formula of sodium sulphate as Na_2SO_4 . We can check the charge balance as follows

$$\left. \begin{array}{l} 2\text{Na}^+ = 2 \times (+1) = +2 \\ 1\text{SO}_4^{2-} = 1 \times (-2) = -2 \end{array} \right\} = 0$$

Thus the compound, Na_2SO_4 is electrically neutral.

Now it is clear that digit showing charge of cation goes to anion and digit showing charge of anion goes to cation. For writing formula of calcium phosphate we take charge of each ion into consideration and write the formula as discussed above.

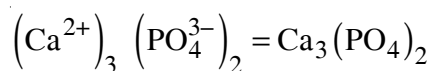

Writing formula of a compound comes only by practice, therefore write formulas of as many ionic compounds as possible based on the guidelines given above.



INTEXT QUESTIONS 3.4

- Write the name of the expected compound formed between
 - hydrogen and sulphur
 - nitrogen and hydrogen
 - magnesium and oxygen

2. Propose the formulas and names of the compounds formed between
 - (i) potassium and iodide ions
 - (ii) sodium and sulphate ions
 - (iii) aluminium and chloride ions
3. Write the formula of the compounds formed between
 - (i) Hg^{2+} and Cl^-
 - (ii) Pb^{2+} and PO_4^{3-}
 - (iii) Ba^{2+} and SO_4^{2-}



Notes

**WHAT YOU HAVE LEARNT**

- According to *law of constant proportions*, a sample of a pure substance always consists of the same elements combined in the same proportion by mass.
- When an element combines with another element and forms more than one compound, then different masses of the one element that combine with the fixed mass of another element are in the ratio of simple whole number or integer. This is the *law of multiple proportions*.
- John Dalton introduced the idea of an atom as an indivisible particle. An atom is the smallest particle of an element which shows all the properties of that element. An atom can not exist freely and therefore remains in a combined state.
- A molecule is the smallest particle of an element or of a compound which shows all properties of that substance and can exist freely under ordinary conditions.
- A molecule can be represented in the form of a chemical formula using symbols of elements that constitute it.
- Composition of any compound can be represented by its chemical formula.
- Atom of the isotope C-12 is assigned atomic mass unit of 12 and the relative atomic masses of all other atoms of elements are obtained by comparing them with it.
- **The mole is the amount of a substance which contains the same number of particles (atoms, ions or molecule)** as there are atoms in exactly 0.012 kg of carbon-12.
- Avogadro's number is defined as the number of atoms in exactly 0.012 kg (or 12 g) of C-12 and is equal to 6.02×10^{23} . Avogadro's constant is written as $6.02 \times 10^{23} \text{ mol}^{-1}$.



Notes

- Mass of one mole atoms or one mole molecules or one mole of formula unit of a substance is its **molar mass**.
- The composition of any compound can be represented by its formula. For writing the formula of a compound, valence or valency of an element is used. This is normally done in case of covalent compounds.
- Valency is the combining capacity of an element and is related to its electronic configuration.
- In ionic compounds, the charge on each ion is used to determine the chemical formula of the compound.



TERMINAL EXERCISE

- Describe the following:
 - Law of conservation of mass
 - Law of constant proportions
 - Law of multiple proportions
- What is the atomic theory proposed by John Dalton? What changes have taken place in the theory during the last two centuries?
- Write the number of protons, neutrons and electron in each of the following isotopes :

$${}^2_1\text{H}, \quad {}^{18}_8\text{O}, \quad {}^{19}_9\text{F}, \quad {}^{40}_{20}\text{Ca}$$
- Boron has two isotopes with masses 10.13 u and 11.01 u and abundance of 19.77% and 80.23% respectively. What is the average atomic mass of boron?
(Ans. 10.81 u)
- Give symbol for each of the following isotopes:
 - Atomic number 19, mass number 40
 - Atomic number 7, mass number 15
 - Atomic number 18, mass number 40
 - Atomic number 17, mass number 37
- How does an element differ from a compound? Explain with suitable examples.
- Charge of one electron is 1.6022×10^{-19} coulomb. What is the total charge on 1 mol of electrons?



Notes

8. How many molecules of O_2 are in 8.0 g of oxygen? If the O_2 molecules were completely split into O (Oxygen atoms), how many mole of atoms of oxygen would be obtained?
9. Assume that human body is 80% water. Calculate the number of molecules of water that are present in the body of a person whose weight is 65 kg.
10. Refer to atomic masses given in the Table (3.2) of this chapter. Calculate the molar masses of each of the following compounds :
HCl, NH_3 , CH_4 , CO and NaCl
11. Average atomic mass of carbon is 12.01 u. Find the number of moles of carbon in (a) 2.0 g of carbon. (b) 8.0 g of carbon.
12. Classify the following molecules as di, tri, tetra, penta and hexa atomic molecules:
 H_2 , P_4 , SF_4 , SO_2 , PCl_3 , CH_3OH , PCl_5 , HCl
13. What is the mass of
 - (a) 6.02×10^{23} atoms of oxygen
 - (b) 6.02×10^{23} molecules of P_4
 - (c) 3.01×10^{23} molecules of O_2
14. How many atoms are present in:
 - (a) 0.1 mol of sulphur
 - (b) 18.g of water (H_2O)
 - (c) 0.44 g of carbon dioxide (CO_2)
15. Write various postulates of Dalton's atomic theory.
16. Convert into mole:
 - (a) 16 g of oxygen gas (O_2)
 - (b) 36 g of water (H_2O)
 - (c) 22 g of carbon dioxide (CO_2)
17. What does a chemical formula of a compound represents?
18. Write chemical formulas of the following compounds:
 - (a) Copper (II) sulphate
 - (b) Calcium fluoride
 - (c) Aluminium bromide
 - (d) Zinc sulphate
 - (e) Ammonium sulphate



Notes



ANSWERS TO INTEXT QUESTIONS

3.1

- (i) Lavoisier proposed the law of conservation of mass and Proust proposed the law of constant proportions
- (ii) In container, 12g of Oxygen was left unreacted. Therefore, amount of unreacted Oxygen = $(20 - 12)\text{g} = 08\text{g}$. Thus 12g of magnesium reacted with 8g of oxygen in the ratio 12:8. This is what we expected for MgO i.e 24g of Mg reacted with 16g of Oxygen or 12g of Mg will react with 8g of Oxygen.

3.2

- (i) Atomic mass of nitrogen is 14u and that of oxygen is 16u.

In NO, 14g of nitrogen reacted with 16g of oxygen

In NO₂, 14g of nitrogen reacted with 32g of oxygen

In N₂O₃, 28g of nitrogen reacted with 48g of oxygen

or

14g of nitrogen reacted with 24g of Oxygen.

Therefore, amount of oxygen which reacts with 12g of nitrogen in case of NO, NO₂ and N₂O₃ will be in the ratio of 16:32:24 or 2:4:3. This proves the law of multiple proportions.

- (ii) Atomic number of Si is 14

Mass number of silicon atoms having 14,15 and 16 neutrons will be 28,29 and 30 respectively and therefore symbols of isotopes of silicon will be



- (iii) Molecular mass of C₂H₄ = mass of two atom of carbon + mass of 4 atom of hydrogen

$$= 2 \times 12\text{u} + 4 \times 1\text{u} = 28\text{u}$$

Molecular mass of H₂O = mass of two atoms of hydrogen + mass of one atom of oxygen

$$= 2 \times 1\text{u} + 1 \times 16\text{u} = 18\text{u}$$

Molecular mass of CH₃OH = mass of one atom of carbon + mass of 4 atoms of hydrogen + mass of one atom of oxygen

$$= 1 \times 12\text{u} + 4 \times 1\text{u} + 1 \times 16\text{u} = 32\text{u}$$

3.3

- 1 mole of a substance contains 6.023×10^{23} molecules of that substance i.e
1 mole of a substance = 6.023×10^{23} molecules of that substance.
- Molecular mass is the sum of atomic masses of all the atoms present in that molecule.

Molecular mass is the mass of one molecule whereas molar mass is the mass of 1 mol or 6.023×10^{23} elementary entities (atoms, molecules, ions)

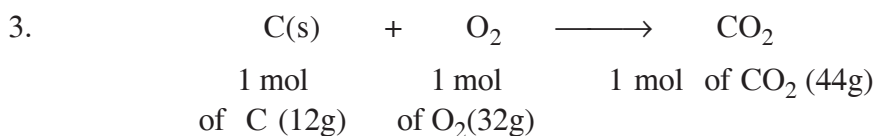

12 g of carbon gives 1 mole of CO_2

18g of carbon will give 1.5 mole of CO_2

- Molar mass of $\text{NaCl} = (23.0 + 35.5) \text{ g mol}^{-1}$
 $= 58.5 \text{ g mol}^{-1}$

3.4

- H_2S
 - NH_3
 - MgO
- KI, Potassium iodide
 - Na_2SO_4 , Sodium Sulphate
 - AlCl_3 , Aluminium Chloride
- HgCl_2
 - $\text{Pb}_3(\text{PO}_4)_2$
 - BaSO_4



Notes



CHEMICAL REACTION AND EQUATIONS

Everyday we observe different types of changes in our surroundings. Some of these changes are very simple and are of *temporary nature*. Some others are really complex and of *permanent nature*. When ice kept in a tumbler is exposed to the atmosphere, it melts and is converted into water. When the tumbler containing this water is kept in a freezer it is converted again into ice. Thus, this is a temporary change and the substance comes to its original form. Such changes are **physical changes**. However, milk once converted into curd can not be converted into milk again. Such changes are **chemical changes**. These changes are of permanent nature. Both physical and chemical changes are integral part of our daily life. We can present these changes in the form of an equation.

In this lesson we shall discuss how to write and balance chemical equations. We shall also describe different types of chemical reactions.



OBJECTIVES

After completing this lesson, you will be able to:

- write and balance simple chemical equations;
- describe the significance of a balanced chemical equation;
- explore the relationship between mole, mass and volume of various reactants and products;
- classify chemical reactions as combination, decomposition, displacement and double displacement reactions and
- define oxidation and reduction processes (redox reactions) and correlate these with corrosion and rancidity and other aspects of daily life.

4.1 CHEMICAL EQUATIONS

You must have observed many chemical changes in nature, in your surroundings and in your daily lives. Let us perform a few activities to observe changes.



ACTIVITY 4.1

- A. Take a 2 cm long magnesium ribbon. Clean it with a piece of sand paper. Hold it firmly with a pair of tongs. Heat it over a spirit lamp or a burner until it burns. Keep the ribbon as far as possible from your eyes. What do you observe? The magnesium ribbon burns with a dazzling light and liberates a lot of heat. It is soon converted into a white powdery substance.



Fig. 4.1: *Burning of magnesium ribbon*

- B. Take a few zinc granules in a conical flask or in a test tube. Add dilute sulphuric or hydrochloric acid to it. What do you observe? There is evolution of gas from the test tube. If you touch the bottom of the test tube, you will find that it has become quite warm.

You can perform many more such activities in the laboratory or in the activity room.

4.1.1 How does one describe these Chemical Changes?

The two reactions mentioned above can be written in words as follows :



Notes



Notes



A substance which undergoes a chemical change is called the **reactant** and the substance which is formed as a result of a chemical change is called the **product**. In reaction (1) magnesium and oxygen undergo chemical change and they are the reactants. In reaction (2) zinc and dilute sulphuric acid are the reactants. Similarly in reaction (1) magnesium oxide is a new substance formed. It is the product. Can you now say what is the product in reaction (2)? Yes, it is zinc sulphate and hydrogen. In chemical reaction, the reactant (s) is (are) written on the left hand side and the product(s) is (are) written on the right hand side. The change of the reactant into the product is shown through an arrow. Use of + sign is made when there are more than one reactant or there are more than one product. Let us see if you can complete the reaction given below:



4.1.2 Writing a Chemical Equation

Is there any other shorter way for representing a chemical change? Yes this can be done through a chemical equation. A chemical equation can be made more concise and useful if we use chemical formulae instead of words. In the previous lesson you have already studied how to represent compound with the help of a chemical formula. Now if you substitute formulae of magnesium, oxygen and magnesium oxide for the words in equation (1), we get



Similarly substituting formulae for words in equation B, we get,



Do you remember the **Law of conservation of mass** studied in the previous lesson? According to it, the mass and the number of atoms present in the reactant(s) should be equal to the mass and number of atoms present in product(s). Let us count the number of atoms on both sides (left hand side and right hand side) of the chemical equations (3) and (4). We find that in equation (3), the numbers of oxygen atoms on the right hand side and the left hand side are not equal. However in (4), the number of atoms on both the sides is equal. Such chemical equations in which the number of atoms is not equal on both sides of the arrow but still represent chemical reactions are called **skeletal chemical equations**. Skeletal chemical equations can be balanced by using suitable **coefficients** in the equation. We shall study the balancing of chemical equation in the following section.

4.2 BALANCED CHEMICAL EQUATIONS

According to the law of conservation of mass, matter can neither be created nor destroyed. Thus, *mass of each element present in the products of a chemical reaction must be equal to its mass present in the reactants*. In other words, the number of atoms of each element remains the same before and after a chemical reaction. In a balanced chemical equation number of atoms of a particular element present in the reactants and products must be equal. If not, equation is said to be 'not balanced.' Let us reconsider the above two equations (3) and (4).

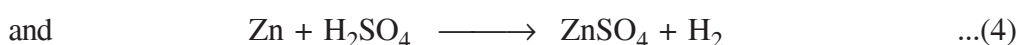
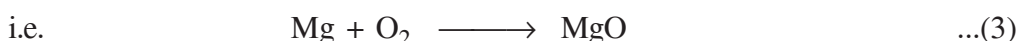

Which one of the above two is balanced? It is quite obvious that equation (4) is balanced, as the number of Zn, H and S (sulphur) atoms are equal on both sides of the equation. Therefore equation (4) is said to be a *balanced chemical equation*. Now what about equation (3)? By simple inspection we can see that the number of atoms of magnesium in the reactant side is equal to the number of atoms of magnesium in the product side. However, the number of atoms of oxygen on the reactant side is two (in O_2) but only one atom of oxygen is in the product side in (MgO). To make the same number of atoms of oxygen in the product side, we shall have to write 2MgO . Now the equation becomes;

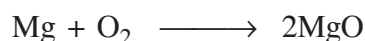

In the above equation there is a shortage of one atom of magnesium on the left hand side. For balancing the number of magnesium atoms, we need to put 2 before Mg and the equation becomes,

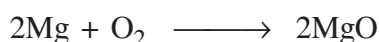

Now the number of magnesium and oxygen atoms is equal on both sides of the arrow and the chemical equation is said to be balanced. This method of balancing of a chemical equation is called the *Hit and Trial method*.

Let us consider another reaction for writing and balancing of a chemical reaction. When steam is passed over red hot iron, hydrogen gas (H_2) is evolved and magnetic oxide of iron (Fe_3O_4) is obtained. This can be expressed as:

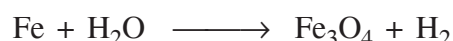

If we examine the above equation we find that the equation is not balanced. Let us try to balance it using the following steps:



Notes



Notes

Step I: Study the equation carefully and write the number of atoms of different elements in the imbalanced equation:



Table 4.1 Comparing number of atoms of different elements in reactants and products

Element	Number of atoms on reactants side (LHS)	Number of atoms on products side (RHS)
Fe	1	3
H	2	2
O	1	4

Step II: We should start balancing with the compound that contains the maximum number of atoms. The compound may be a reactant or a product. In the compound, select the element which has maximum number of atoms. Based on this select Fe_3O_4 in the above equation. In Fe_3O_4 the element oxygen has the maximum number of atoms. There are four oxygen atoms on the right hand side and only one oxygen atom on the left hand side of the arrow. For balancing the oxygen atoms, we can put the coefficient '4' as ' $4\text{H}_2\text{O}$ '. Now the equation becomes:



Step III: Here Fe and H atoms are still not balanced. Let us balance the hydrogen atoms. For this, make the number of molecules of hydrogen as four on the RHS of the arrow. The equation now becomes:



Step IV: Now, out of the three elements, only Fe remains imbalanced. For balancing iron, we write 3 atoms of iron on left hand side and the equation becomes:



Step V: Finally count the number of atoms of all the three elements on both sides of the arrow. You will find that the number of atoms of oxygen, hydrogen and iron on both sides of the arrow are equal and thus the balanced equation is obtained as:



4.2.1 How can we make a Chemical Equation more Informative?

In the balanced equation

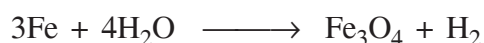

we have no information about the physical states of the reactants and the products i.e. whether they are solid, liquid or gas. By using (s) for solids, (l) for liquids and (g) for gases along with reactants and products, we can make a chemical equation more informative. Thus, the above equation can be written as:



Here, (g) by the side of H_2O clearly indicates that water used in the reaction is in the form of steam or gas. Further, if a reactant or a product is taken as solution in water, we denote it by writing (aq). For example.

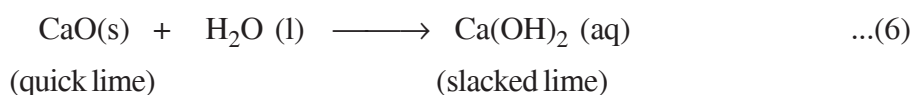

Sometimes the reaction conditions such as temperature, pressure, catalyst, etc. for the reaction are also indicated above and/or below the arrow in the equation. For example,

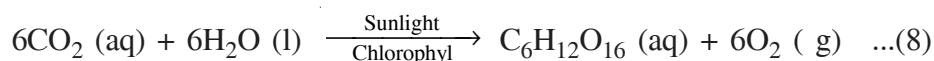

Important Tips for balancing a chemical equation

- Use the simplest possible set of whole number coefficients to balance a chemical equation. Normally we do not write fractional coefficients in such equations as molecules are not available in fractions. We multiply the equation by an appropriate number to ensure the entire equation has whole number coefficients.
- Do not change subscripts in formulae of reactants or of products during balancing, as that may change the identity of the substances. For example, 2NO_2 means two molecules of nitrogen dioxide but if we double the subscript we get N_2O_4 which is the formula of dinitrogen tetroxide, a completely different compound.

4.3 SIGNIFICANCE OF A BALANCED CHEMICAL EQUATION

Qualitatively a chemical equation simply describes what the reactants and products are. However, *a balanced chemical equation gives a lot of quantitative information about a chemical reaction.* A balanced chemical equation tells us:

- the number of atoms and molecules taking part in the reaction and the corresponding masses in atomic mass unit (amu or u).
- the number of moles taking part in the reaction, with the corresponding masses in grams or in other convenient units.
- relationship between the volume of the reactants and the products if all of them are in the gaseous state.



Notes



Notes

4.3.1 Mole and Mass Relationships

Let us consider a chemical reaction between nitrogen and hydrogen in the presence of a catalyst.

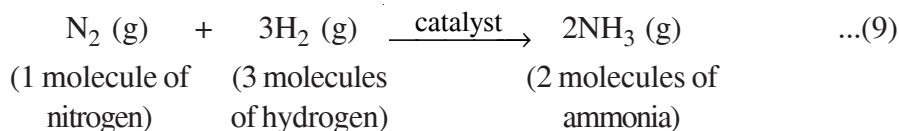

We may multiply the entire equation by any number, say 100, we obtain

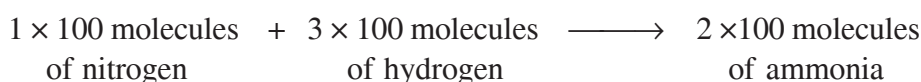

Suppose, we multiply the entire equation by 6.022×10^{23} , (Avogadro's number) we get

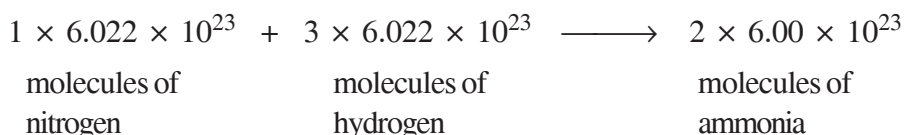

Since 6.022×10^{23} molecules of any substance constitute its one mole, therefore, we can write



Taking molar mass into consideration, we can write



Let us write the equation (9) once again,

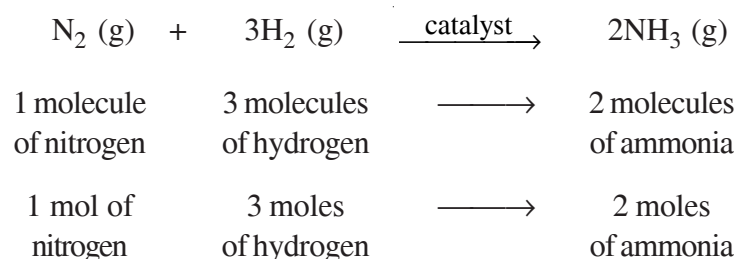

Remember

Quantity of a substance consumed or produced can be determined only if we use a balanced chemical equation.

4.3.2 Volume Relationship for Reactions involving gases

The French chemist, Gay Lussac found that the volume of reactants and products in gaseous state are related to each other by small integers, provided the volumes are measured at the same temperature and pressure.

Gay Lussac's discovery of integer ratio in volume relationship is actually the *law of definite proportion by volume*. Remember, the law of definite proportion studied in lesson 3: Atoms and Molecules, was with respect to masses.

Let us take the following example

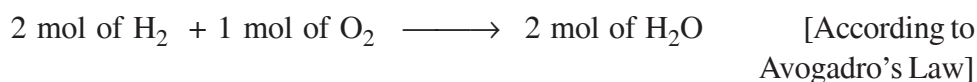
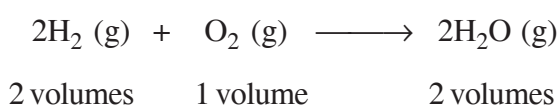

Here, hydrogen, oxygen and water vapours are at the same temperature and pressure (say 100°C and 1 atmospheric pressure). From this basic concept we can conclude that, if we take 100 mL of hydrogen and 50 mL of oxygen, we shall get 100 mL water vapour provided all volumes are measured at the same temperature and pressure. Thus, from a balanced chemical equation, we get relationship between mole, mass and volume of the reactants and products. This quantitative relationship has been found very useful in chemical calculations.

**INTEXT QUESTION 4.1**

- Write a chemical equation for each of the following reactions:
 - Zinc metal reacts with aqueous hydrochloric acid to produce a solution of zinc chloride and hydrogen gas.
 - When solid mercury(II) oxide is heated, liquid mercury and oxygen gas are produced.
- Balance the following chemical equations:
 - $\text{H}_2\text{SO}_4 (\text{aq}) + \text{NaOH} (\text{aq}) \longrightarrow \text{Na}_2\text{SO}_4 (\text{aq}) + \text{H}_2\text{O} (\text{l})$
 - $\text{Al} (\text{s}) + \text{HCl} (\text{aq}) \longrightarrow \text{AlCl}_3 (\text{aq}) + \text{H}_2 (\text{g})$
- What is a balanced chemical equation? Why should a chemical equation be balanced?



Notes



Notes

4.4 TYPES OF CHEMICAL REACTIONS

So far we have studied how to express a chemical change in the form of an equation. We have also studied how to balance a chemical equation in order to derive useful quantitative information. We can classify chemical reactions into the following categories (i) combination reactions, (ii) decomposition reactions (iii) displacement reactions (iv) double displacement reactions.

4.4.1 Combination Reactions

In combination reactions, as the name indicates, two or more substances (elements or compounds) simply combine to form a new substance. For example, when a substance burns it combines with oxygen present in the air. In activity 4.1 we have seen that magnesium ribbon burns with dazzling light. During burning it combines with oxygen as

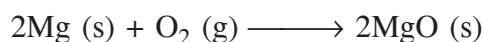

Now try the same with carbon.

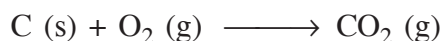

Further, let us take a few activities.



ACTIVITY 4.2

Take a small amount of calcium oxide (CaO) or quick lime in a beaker. Now slowly add water to it (Fig. 4.2). Touch the side of the beaker with your hand. Do you feel any change in the temperature? Yes, it is warm to touch. You might have seen that for white-washing we put white solid material in water and after some time it starts boiling. This white material is calcium oxide and it reacts with water to form calcium hydroxide. Temperature rises due to evolution of heat in the reaction between quick lime and water. This reaction can be expressed in the form of the following equation:

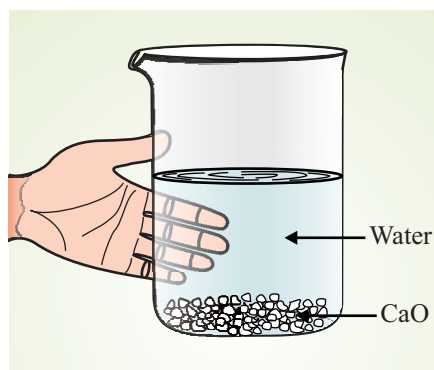
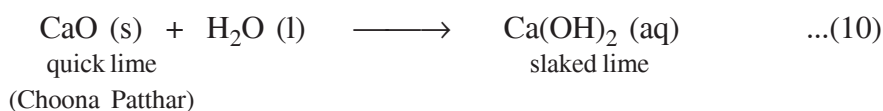
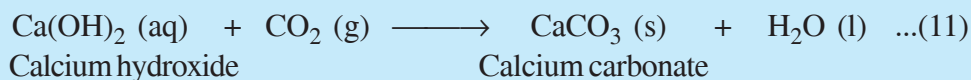

Fig. 4.2: Reaction between quick lime and water



In the above reaction calcium oxide (quick lime) and water combine and form a single product-calcium hydroxide (slaked lime). Such a reaction in which a single product is formed from two or more reactants is known as combination reaction.

In white washing, when slaked lime is applied on the walls it gradually reacts with carbon dioxide from the atmosphere. The bluish coloured calcium hydroxide (slaked lime) is converted into white calcium carbonate. After drying, it gives a white shiny finish. This reaction can be written as follows:



It is interesting to note that chemical formula of marble is also CaCO_3 .

In activities 4.1 and 4.2 you have seen that a lot of heat is evolved during the course of the reaction. Such reactions in which heat is released along with the formation of the products are called **exothermic reactions**.

Other examples of exothermic reactions are:

- (i) Burning of natural gas (CH_4) used for cooking.



- (ii) Respiration and digestion both are exothermic process. This heat energy comes from the food that we eat. Do you know what types of food give us energy? Food which we take in the form of rice, potatoes and bread contains **carbohydrates**. Carbohydrates are broken down to glucose during digestion. The glucose combines with oxygen in the cells of our body and provides energy to our body.

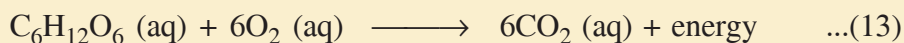

People who do physical work, require a lot of energy and therefore, require carbohydrates in the form of sugar, potato, rice, bread, etc.

- (iii) The decomposition of vegetable matter or *biomass* into compost is also an example of an exothermic reaction. If you have a compost pit in your surroundings, you can observe this yourself.

4.4.2 Decomposition Reactions

You have seen earlier that quick lime (*choona patthar*) solution is used for whitewashing of our houses. Have you ever thought how this quick lime is obtained? It is obtained by heating lime stone in a furnace (*bhatti*). Lime stone when heated gives lime and carbon dioxide.

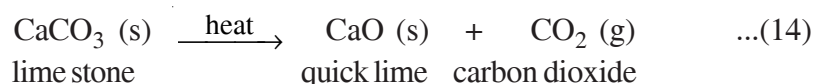

This reaction is an example of a decomposition reaction. **A decomposition reaction is the one in which a compound decomposes into two or more than two substances (elements or compounds)**. Let us now carry out some activities.



Notes



Notes



ACTIVITY 4.3

Take about 2 g of ferrous sulphate in a hard glass test tube as shown in Fig. 4.3. Hold the test tube with a test tube holder and gently heat it over the flame. After heating for about one minute, observe the change in colour of ferrous sulphate. Smell the odour of the gas carefully. What do you observe? The green colour of the ferrous sulphate crystals gradually fades away and a smell of burning sulphur is found.

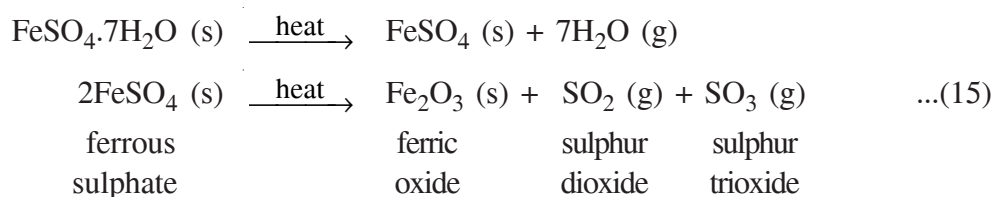

Here ferrous sulphate ($\text{FeSO}_4 \cdot 7\text{H}_2\text{O}$) crystal first loses water and then decomposes to SO_2 and SO_3 gases.

Another example of a decomposition reaction is given below:

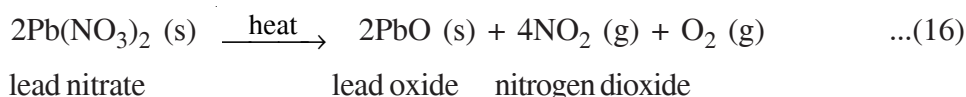

In the reactions given above, decomposition occurs by application of heat. Such reactions fall in the category of **thermal decomposition**.

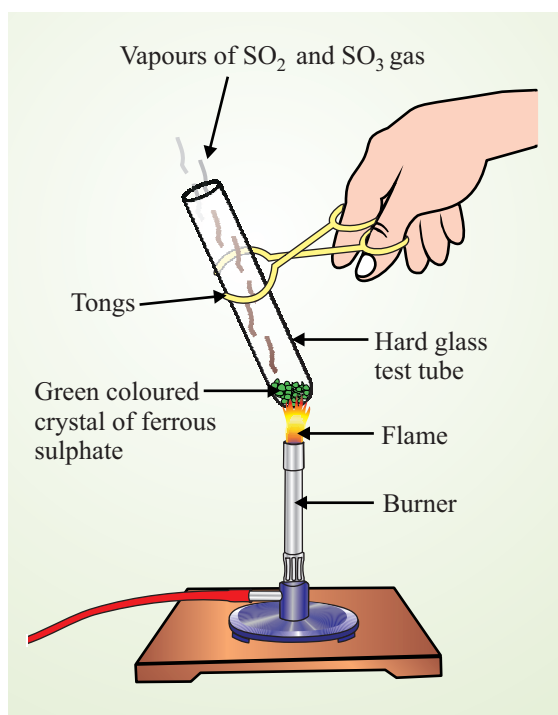

Fig. 4.3: Thermal decomposition of ferrous sulphate



ACTIVITY 4.4

Take a plastic mug. Drill two holes at its base and fit rubber stoppers in these holes. Insert graphite electrodes in these rubber stoppers as shown in Fig. 4.4. Connect these electrodes to a 6 volt battery.

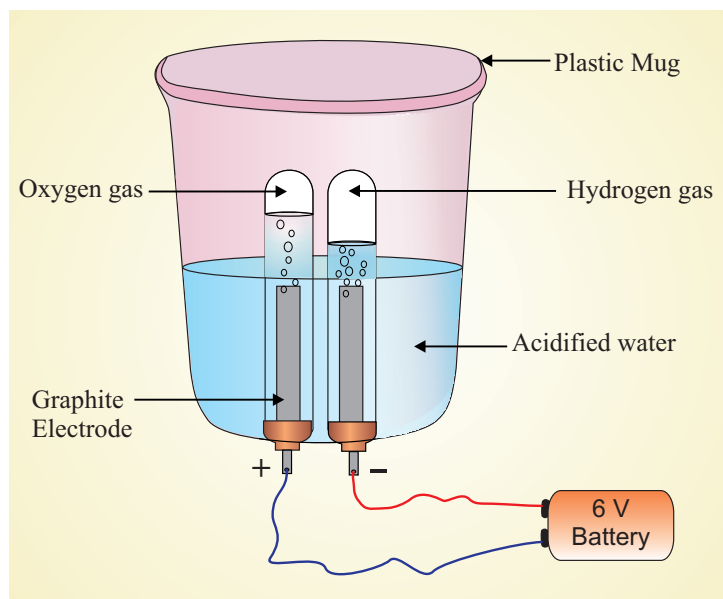

Fig. 4.4: Electrolysis of water

Now observe carefully what happens. You will find bubbles of gases over both the electrodes. Take two test tubes. Fill them with water and invert them over two graphite electrodes. Bubbles formed at the electrodes are found to replace water filled in the two test tubes. After sometime observe the volume of the two gases. You will find that the volume ratio of the two gases (oxygen and hydrogen) is 1:2. Carefully remove both the test tubes containing these gases one by one and test them with the help of your tutor at the study centre.

The two gases are hydrogen and oxygen and their volumes are in the ratio of 2:1 respectively (Gay Lussac's Law). The decomposition of water in this experiment takes place due to the electrical current that is passed through the water. A **reaction in which a compound decomposes due to electrical energy into two or more than two substances (elements or compounds) is called electrolytic decomposition reaction.**

4.4.3 Displacement Reaction

For understanding this types of reaction, perform the following activity.



Notes



Notes



ACTIVITY 4.5

Take about 10 mL of dilute copper sulphate solution in each of the two test tubes and mark them as A and B. Now take two iron nails and clean them with sand paper. In test tube A, immerse one iron nail with the help of a thread as shown in Fig. 4.5. After nearly 20 minutes, observe the changes taking place on the surface of the iron nail and also in the colour of copper sulphate solutions. Compare the colour of the solution in test tube A with the colour of the solution in test tube B. What do you observe? The blue colour of copper sulphate solution fades. Similarly, compare the colour of the iron nail dipped in solution A with the other iron nail. You will see that the surface of the nail has become brownish. Do you know why the iron nail becomes brownish and the blue colour of copper sulphate solution fades?

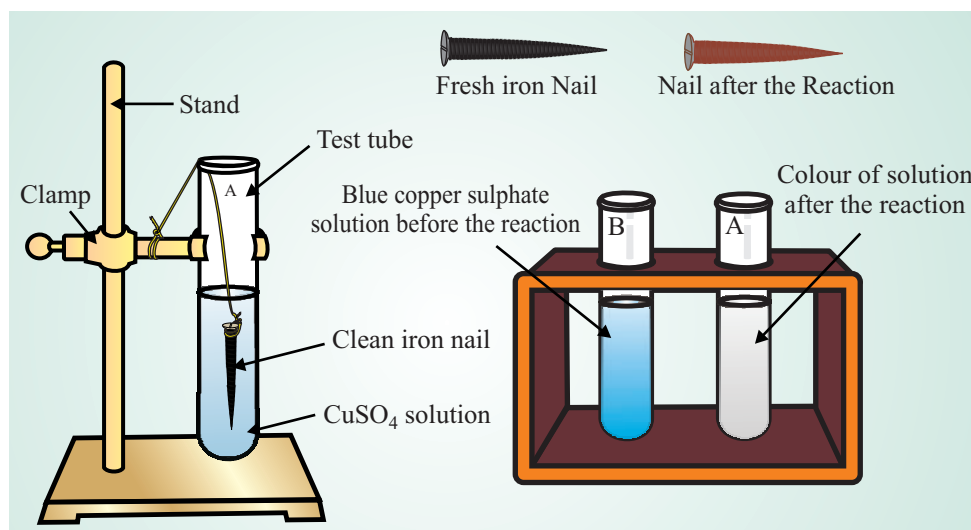
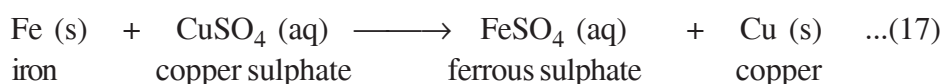

Fig. 4.5: Reaction between iron and copper sulphate

All this happens due to the following chemical reaction,



In this reaction, one element i.e. iron has displaced another element i.e. copper from copper sulphate solution. These types of reactions fall in the category of **displacement reactions**. *The displacement reaction is one in which one element displaces another element from its compounds.*

Other examples of displacement reactions are:





Since zinc and lead are more reactive metals than copper therefore they displace copper from its compound.

4.4.4 Double Displacement Reactions

For understanding this type of reactions, perform the following activity.



ACTIVITY 4.6

Take two test tubes and mark them A and B. In test tube A take nearly 4 mL of sodium sulphate solution and in test tube B take nearly 4 mL of barium chloride solution. Now add solution of test tube A to solution of test tube B. What do you observe? A white substance is formed which is known as a **precipitate**. The reaction can be written as,

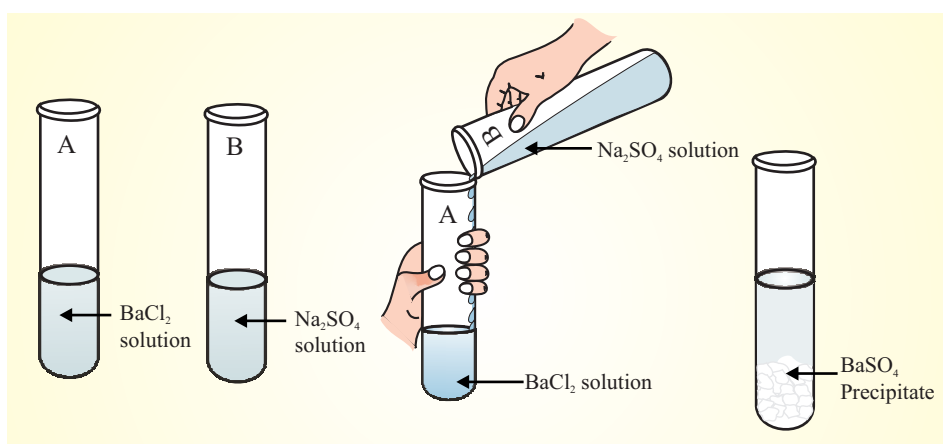
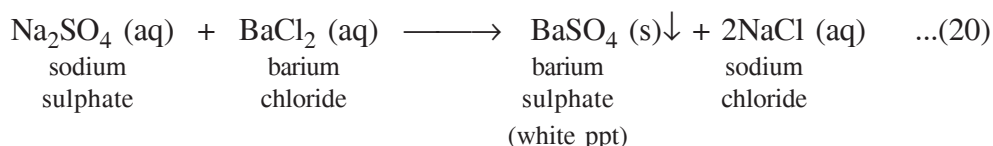

Fig. 4.6: Precipitation reaction between sodium sulphate and barium chloride

The white precipitate of BaSO_4 is formed by the reaction of Ba^{2+} ions and SO_4^{2-} ions. The other product formed is sodium chloride which remains in solution. **Reactions in which there is an exchange of ions between the reactants, are called double displacement reactions.**

Find out different types of reaction occurring in your compounds.

4.5 OXIDATION AND REDUCTION (REDOX REACTION)

In order to understand the redox reactions, let us perform the following activity.



Notes

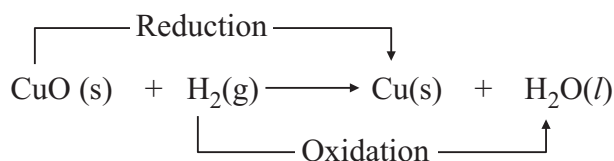

In the above scheme, CuO provides oxygen and therefore is an oxidizing agent and hydrogen takes this oxygen and therefore is a reducing agent. In a redox reaction, an oxidizing agent is reduced and a reducing agent is oxidized.

Some other examples of redox reaction are :

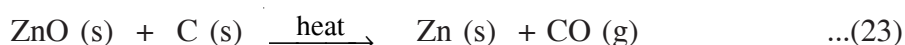

In all redox reactions, you have seen that one species is oxidized and the other is reduced. ***There is no oxidation without reduction and there is no reduction without oxidation.*** This aspect of redox reactions will be explained broadly in terms of ***electron gain*** and ***electron loss*** in the following section.

4.5.1 Redox Reactions in terms of Electron gain and Electron Loss

You just learnt oxidation and reduction in terms of gain and loss of oxygen and hydrogen. However, defining a redox reaction in this way is confined to only a few reactions.

Let us consider the reactions

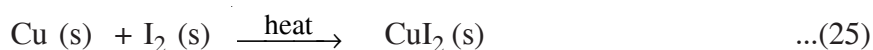

These reactions do not involve any gain or loss of oxygen or hydrogen. Yet these are oxidation-reduction reactions. The reaction (25),



can be written in two steps as follows:

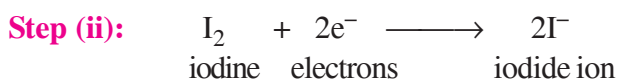
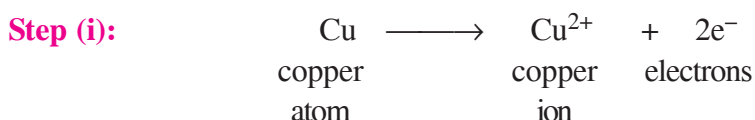

In step (i) one copper atom loses two electrons to become a cupric ion, Cu^{2+} and in step (ii) iodine gains two electrons and gets converted into two iodide ions. Here



Notes



Notes

we say, copper is oxidized by losing electrons and iodine is reduced by gaining electrons. Thus *a reaction in which a species loses electrons is called an oxidation reaction and a reaction in which a species gains electrons is called a reduction reaction.* The substance which oxidizes the other substance is known as an *oxidizing agent*. An oxidizing agent gets reduced during the reaction. Likewise, the substance which reduces the other substance is known as a *reducing agent*. A reducing agent gets oxidized during the reaction. In reaction (25), copper acts as a reducing agent and iodine as an oxidizing agent.

Similarly, in reaction (26) iron acts as a reducing agent and sulphur as an oxidising agent.

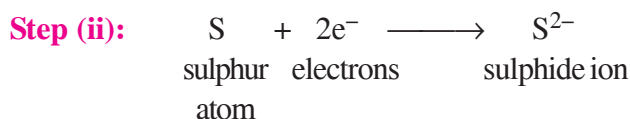
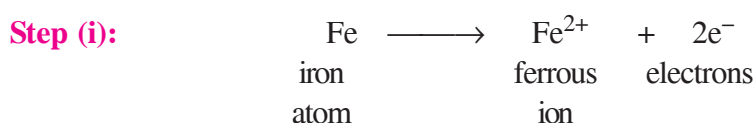

Now, you can answer the following in the space provided

- (i) Reducing agent:
- (ii) Oxidising agent:
- (iii) element which is oxidised:
- (iv) Element which is reduced

[**Hint:** Your answer should be as per rule given below]

Gain of electron is reduction and loss of electron is oxidation.

As mentioned earlier, oxidation and reduction processes occur simultaneously.

Consider the following displacement reaction

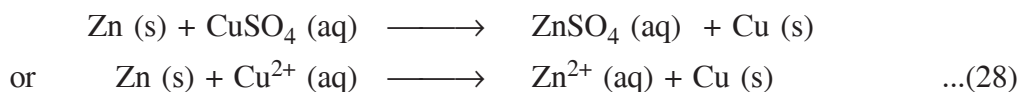

Here, Zn loses electrons and gets converted into Zn²⁺ (aq). These electrons lost by Zn are gained by Cu²⁺ ion which gets converted into Cu. This broad definition of reduction-oxidation can be applied to many more reactions.

A few more examples of redox reaction are given below:

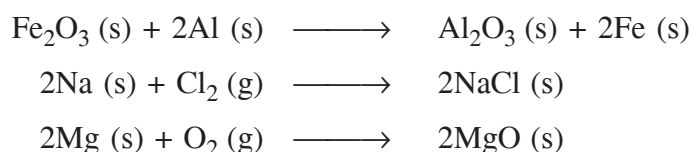



INTEXT QUESTIONS 4.2

- Examine the following reaction(s) and identify which of them are **not** example(s) of a redox reaction?
 - $\text{AgNO}_3 (\text{aq}) + \text{HCl} (\text{aq}) \longrightarrow \text{AgCl} (\text{s}) + \text{HNO}_3 (\text{aq})$
 - $\text{MnO}_2 (\text{s}) + 4\text{HCl} (\text{aq}) \longrightarrow \text{MnCl}_2 (\text{aq}) + 2\text{H}_2\text{O} (\text{l}) + \text{Cl}_2 (\text{g})$
 - $4\text{Na} (\text{s}) + \text{O}_2 (\text{g}) \longrightarrow 2\text{Na}_2\text{O} (\text{s})$
- Identify the substances which are oxidized and the substances that are reduced in the following reactions:
 - $\text{H}_2 (\text{g}) + \text{Cl}_2 (\text{g}) \longrightarrow 2\text{HCl} (\text{g})$
 - $\text{H}_2 (\text{g}) + \text{CuO} (\text{s}) \longrightarrow \text{Cu} (\text{s}) + \text{H}_2\text{O} (\text{l})$
 - $\text{Zn} (\text{s}) + 2\text{AgNO}_3 (\text{aq}) \longrightarrow \text{Zn}(\text{NO}_3)_2 (\text{aq}) + 2\text{Ag} (\text{s})$

4.5.2 Effect of Redox Reaction in Everyday Life

We have studied different types of chemical reactions in the previous sections. Out of these reactions, redox reactions are very important in our lives. We would like to discuss corrosion in view of its economic importance. Rancidity is also important in view of its direct link with our foods and edibles. Both of these i.e. corrosion and rancidity are results of redox reactions.

- Corrosion
- Rancidity

A substance capable of destroying bacteria is called a disinfectant or a bactericide or an antiseptic. Most effective disinfectants are strong oxidizers. A bleach oxidises colored compounds to other substance which are not coloured. Many disinfectants including chlorine which are available in different forms as solid compounds such as calcium hypochlorite, $\text{Ca}(\text{ClO})_2$, are oxidising agents. In an oxy-acetylene torch used for welding and cutting metals, acetylene is oxidised and produces very high temperature.

A. Corrosion

Corrosion is a destructive chemical process in which metals are oxidized in presence of air and moisture. The rusting of iron, tarnishing of silver, development of green coatings on copper, brass and bronze are a few examples of corrosion. It causes enormous damage to bridges, ships, cars and to all machines which are made of iron or steel. The damage and efforts taken to prevent it costs several crores of rupees a year. Preventing corrosion is a big challenge for an industrially developing country like ours.



Notes



Notes



ACTIVITY 4.8

Take 3 small beakers and mark them as A, B and C. In each beaker put 3 g of iron nail. In beaker A nothing is added but its mouth is covered with a watch glass. In beaker B add a few drops of water and make the iron nail wet. Leave the beaker B open, i.e. exposed to the atmosphere. In beaker C, add enough water to cover the nail completely (Fig. 4.8). Leave all the beakers for about three days. Observe the changes in all the beakers. Iron nail in beaker A are not affected, in beaker B the iron nail are rusted and in beaker C again the iron nail are not affected. Now write the condition for rusting on the basis of your findings.

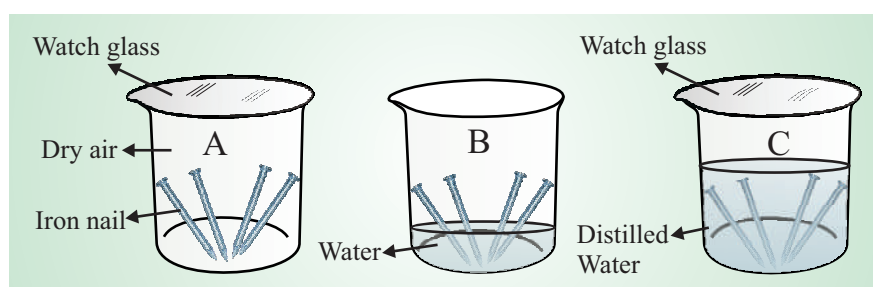

Fig. 4.8

How does one prevent corrosion?

There are several methods for protecting metals from corrosion, especially iron from rusting:

- plating the metal (iron) with a thin layer of less easily oxidized metal like nickel or chromium. This plating keeps out air (oxygen) and moisture which are main causes of corrosion.
- coating/connecting the metal with more reactive metal or with a metal which is more easily oxidized. For example, iron is connected to magnesium or coated with zinc for protecting it from corrosion. Iron rods are dipped in molten zinc to create a layer on their surface. This process of zinc coating over iron is called **galvanization**.
- applying a protective coating such as paint.



Fig. 4.9: Rusted nuts and bolts of iron

B. Rancidity

You might have tasted or smelt fat/oil containing food material left for a long time. What do you find? You will find a lot of difference in the smell of fresh and stale oil or ghee. Why does this happen? This happens because fats and oils undergo oxidation and become rancid. This change is called **rancidity**. Oxidation of fats/oils results into the formation of acids. These acids give unpleasant smell and bad taste.

Many food items which are cooked/fried in oil/fat are kept in air tight containers for sale. Keeping food items in air tight containers helps to slow down the oxidation process. Usually substances which prevent oxidation (anti-oxidants) are added to food items containing fats and oils. Do you know that the chips manufacturers usually flush bags of chips with a gas such as nitrogen to prevent oxidation of oil present in chips?



WHAT YOU HAVE LEARNT

- A chemical equation is a shorthand description of a reaction. It symbolically represents the reactants, products and their physical states.
- In a balanced chemical equation, number of atoms of each type involved in the chemical reaction is equal on the reactants and products sides of the equation.
- If charged species are involved, the sum of the charges on reactants should be equal to sum of charges on the products.
- During balancing of a chemical equation, no change in the formula of reactant(s) and product(s) is allowed.
- A balanced chemical equation obeys the law of conservation of mass and the law of constant proportions.
- In a combination reaction two or more substances combine to form a new single substance.
- In a decomposition reaction, a single substance decomposes to give two or more substances. Thus decomposition reactions are opposite to combination reactions.
- Reactions in which heat is given out during product formation are called **exothermic reactions** and reactions in which heat is absorbed during product formation are called **endothermic reactions**.
- A displacement reaction is one in which an element displaces another element from its compound.
- When two different ions are exchanged between two reactants double displacement reaction occurs.
- Precipitation reactions are the result of ion exchange between two substances, producing insoluble salts.



Notes



Notes

- Oxidation is the gain of oxygen or loss of hydrogen and reduction is loss of oxygen or gain of hydrogen. Oxidation and reduction reactions occur simultaneously and are jointly called **redox reactions**.
- Redox reactions can broadly be defined in terms of loss and gain of electrons. Gain of electron(s) is reduction and loss of electrons is oxidation.
- Redox reactions are very important in our life situations as well as in industries.



TERMINAL EXERCISE

- A. Write chemical equations of the following and balance them:
 - Carbon + oxygen \longrightarrow Carbon dioxide
 - Hydrogen + Chlorine \longrightarrow Hydrogen chloride
 - Barium chloride + Sodium sulphate \longrightarrow Barium sulphate + sodium chloride
- B. Write balanced chemical equations with physical state symbols and necessary conditions, if any:
 - Nitrogen reacts with hydrogen in the presence of iron as a catalyst at 200 atmospheric pressure and 600°C temperature, and the product obtained is ammonia.
 - Aqueous solution of sodium hydroxide reacts with hydrochloric acid and produces sodium chloride and water.
 - Phosphorus burns in chlorine gas to form phosphorous pentachloride.
- C. Balance the following chemical reactions:
 - $\text{Ca(OH)}_2 + \text{HNO}_3 \longrightarrow \text{Ca(NO}_3)_2 + \text{H}_2\text{O}$
 - $\text{BaCl}_2 (\text{aq}) + \text{H}_2\text{SO}_4 (\text{aq}) \longrightarrow \text{BaSO}_4 (\text{s}) + \text{HCl} (\text{aq})$
 - $\text{CuSO}_4 (\text{aq}) + \text{Zn} (\text{s}) \longrightarrow \text{ZnSO}_4 (\text{aq}) + \text{Cu} (\text{s})$
 - $\text{H}_2\text{S} (\text{g}) + \text{SO}_2 (\text{g}) \longrightarrow \text{S} (\text{s}) + \text{H}_2\text{O} (\text{l})$
 - $\text{BaCl}_2 (\text{aq}) + \text{Al}_2(\text{SO}_4)_3 (\text{aq}) \longrightarrow \text{AlCl}_3 (\text{aq}) + \text{BaSO}_4 (\text{s})$
 - $\text{Pb} (\text{NO}_3)_2 (\text{aq}) + \text{Fe}_2(\text{SO}_4) (\text{aq}) \longrightarrow \text{Fe}(\text{NO}_3)_3 (\text{aq}) + \text{PbSO}_4 (\text{s})$
 - Calcium hydroxide + carbon dioxide \longrightarrow Calcium carbonate + water
 - Aluminium + Copper (II) chloride \longrightarrow Aluminium chloride + copper
 - Calcium carbonate + hydrochloric acid \longrightarrow Calcium chloride + water + carbon dioxide



Notes

2. What is a balanced chemical equation? Write 3 characteristics of a balanced chemical equations?
3. In what way is a displacement reaction different from a double-displacement reaction? Explain with two suitable examples.
4. What happens when dilute hydrochloric acid is added to iron filings? Mark (✓) at the correct answer from the following:
 - (a) Hydrogen gas and iron chloride are produced and is classified as a displacement reaction.
 - (b) Iron chloride and chlorine gas are produced and is classified as a decomposition reaction.
 - (c) Iron hydroxide and water are produced and is classified as a combination reaction.
 - (d) No reaction takes place but is classified as a double displacement reaction.
7. What do you mean by an exothermic reaction? Give a suitable example.
8. Classify each of the following reactions as combination, decomposition, displacement or double displacement reactions:
 - (a) $\text{Zn (s)} + 2\text{AgNO}_3 \text{ (aq)} \longrightarrow \text{Zn(NO}_3)_2 + 2\text{Ag (s)}$
 - (b) $2\text{KNO}_3 \text{ (s)} \xrightarrow{\text{heat}} 2\text{KNO}_2 + \text{O}_2 \text{ (g)}$
 - (c) $\text{Ni (NO}_3)_2 \text{ (aq)} + 2\text{NaOH (aq)} \longrightarrow \text{Ni(OH)}_2 \text{ (s)} + 2\text{NaNO}_3 \text{ (aq)}$
 - (d) $2\text{KClO}_3 \text{ (s)} \xrightarrow{\text{heat}} 2\text{KCl (s)} + 3\text{O}_2 \text{ (g)}$
 - (e) $\text{MgO (s)} + \text{C (s)} \longrightarrow \text{CO (g)} + \text{Mg (s)}$
9. What is the difference between a combination and a decomposition reaction? Illustrate with suitable examples.
10. Is there any oxidation without reduction? Justify your answer.
11. 'Both combination reaction and displacement reaction fall in the category of redox reactions'. Do you agree? If so discuss this aspect with suitable examples.
12. Give two examples from everyday life situation where redox reaction takes place. How will you prove it?
13. In the following reactions name the substances which are oxidized and reduced and also mention the oxidizing and reducing agents:
 - (a) $\text{Ca (s)} + \text{Cl}_2 \text{ (g)} \xrightarrow{\text{heat}} \text{CaCl}_2 \text{ (s)}$



Notes

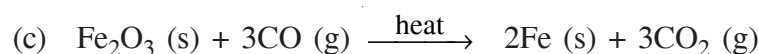
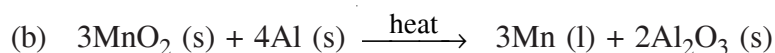

14. Explain the following in terms of electron transfer:

- (a) Oxidation (b) Reduction

17. What is the law of definite proportion by volume? Explain.



ANSWERS TO INTEXT QUESTIONS

4.1

- $\text{Zn}(\text{s}) + 2\text{HCl} (\text{aq}) \longrightarrow \text{ZnCl}_2(\text{aq}) + \text{H}_2(\text{g}) + \text{H}_2$
 - $2\text{HgO} (\text{s}) \longrightarrow 2\text{Hg} (\text{l}) + \text{O}_2$
- $\text{H}_2\text{SO}_4 (\text{aq}) + 2\text{NaOH} (\text{aq}) \longrightarrow \text{Na}_2\text{SO}_4 (\text{aq}) + 2\text{H}_2\text{O} (\text{l})$
 - $2\text{Al} (\text{s}) + 6\text{HCl} (\text{aq}) \longrightarrow 2\text{AlCl}_3 (\text{aq}) + 3 \text{H}_2 (\text{g})$
- Volume of reactant and products in gaseous chemical reactions are related to each other by small integers, provided the volume are measured at the same temperature and pressure. In a balanced gaseous chemical equation we get relation between volume and between the moles of the reactants and products.

4.2

- Following equation is not example of a redox reaction :
 - $\text{AgNO}_3(\text{aq}) + \text{HCl} (\text{aq}) \longrightarrow \text{AgCl}(\text{s}) + \text{HNO}_3(\text{aq})$
- H_2 is oxidized and Cl_2 is reduced.
 - H_2 is oxidized and CuO is reduced.
 - Zn is oxidized and Ag^+ (in AgNO_3) is reduced.



5

ATOMIC STRUCTURE

In lesson 3, you have studied about atoms and molecules as the constituents of matter. You have also learnt that the atoms are the smallest constituents of matter. In lesson 4 you studied about the chemical reactions, their types and the ways to represent them. You know that according to Dalton's atomic theory, the atoms of different elements are different and in chemical reactions the atoms are rearranged between different reacting substances. However, today we know that the atom is not indivisible as it was thought by Dalton. The atom has a structure and contains smaller constituents in it. In this unit, we would attempt to find out the answers to some of the questions like, "What is the structure of an atom?", "What are the constituents of atoms?", "Why the atoms of different elements are different?" and so on.

We will begin this unit with the study of the discoveries of sub-atomic particles such as electron, proton etc. Then, we will take up various atomic models proposed on the basis of these discoveries. We will discuss how various models for the structure of atom were developed and also explain the success as well as the shortcomings of these models. This will be followed by the description of the arrangement or the distribution of electrons in the atom. This arrangement is known as *electronic configuration*. These electronic configurations are useful in explaining various properties of the elements. These also determine the nature of chemical bonds formed by it. This aspect is dealt with in lesson 7 on chemical bonding.



OBJECTIVES

After completing this lesson, you will be able to:

- recall the evidences showing the presence of charged particles in matter;
- describe the discovery of electron and proton;
- explain Dalton's atomic theory and its failure;
- discuss Thomson's and Rutherford's models of atom and explain their limitations;



Notes

- explain the Bohr's model of atom (in brief);
- describe the discovery of neutron;
- compare the characteristic properties of proton, electron and neutron;
- explain various rules for filling of electrons and write the distribution of electrons in different shells upto atomic number 20;
- define valency and correlate the electronic configuration of an atom with its valency;
- define atomic number and mass number of an atom;
- describe isotopes and isobars;
- define and compute average atomic mass and explain its fractional value.

5.1 CHARGED PARTICLES IN ATOM

You have read about Dalton's atomic theory in lesson 3. The theory proposed in the year 1803 considered the atom to be the smallest indivisible constituent of all matter. The Dalton's theory could explain the law of conservation of mass, law of constant composition and law of multiple proportions known at that time. However, towards the end of nineteenth century, certain experiments showed that an atom is neither the smallest nor indivisible particle of matter as stated by Dalton. It was shown to be made up of even smaller particles. These particles were called electrons, protons and neutrons. The electrons are negatively charged whereas the protons are positively charged. The neutrons on the other hand are uncharged in nature. You will now learn about the discovery of the charged subatomic particles.

5.1.1 Discovery of Electron

In 1885, Sir William Crookes carried out a series of experiments to study the behaviour of metals heated in a vacuum using cathode ray tubes. A cathode ray tube

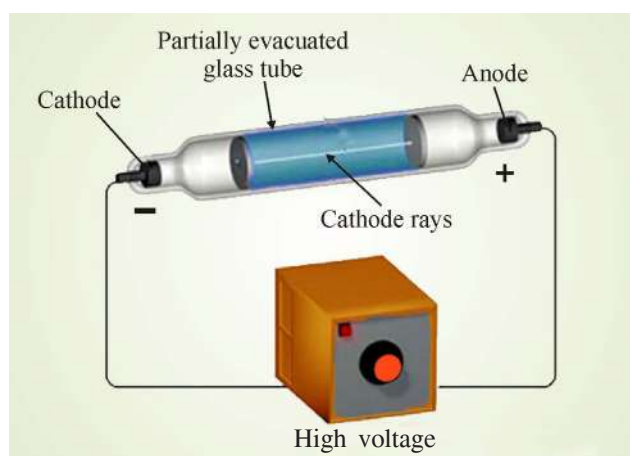

Fig. 5.1: A cathode ray tube; cathode rays are obtained on applying high voltage across the electrodes in an evacuated glass tube

consists of two metal electrodes in a partially evacuated glass tube. An evacuated tube is the one from which most of the air has been removed. The negatively charged electrode is called cathode whereas the positively charged electrode is called anode. These electrodes are connected to a high voltage source. Such a cathode ray tube has been shown in Fig. 5.1.

It was observed that when very high voltage was passed across the electrodes in evacuated tube, the cathode produced a stream of particles. These particles were shown to travel from cathode to anode and were called **cathode rays**. In the absence of external magnetic or electric field these rays travel in straight line. In 1897, an English physicist Sir J.J. Thomson showed that the rays were made up of a stream of negatively charged particles. This conclusion was drawn from the experimental observations when the experiment was done in the presence of an external electric field. Following are the important properties of cathode rays:

- Cathode rays travel in straight line
- The particles constituting cathode rays carry mass and possess kinetic energy
- The particles constituting cathode rays have negligible mass but travel very fast
- Cathode ray particles carry negative charge and are attracted towards positively charged plate when an external electric field is applied (Fig. 5.2)
- The nature of cathode rays generated was independent of the nature of the gas filled in the cathode ray tube as well as the nature of metal used for making cathode and anode. In all the cases the charge to mass ratio (e/m) was found to be the same.

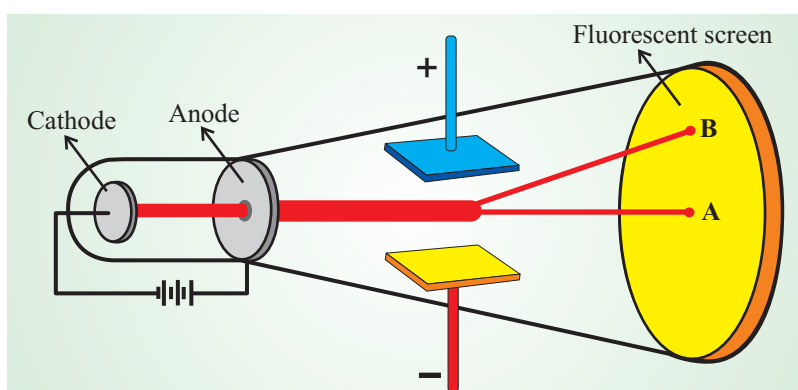

Fig. 5.2: The cathode rays are negatively charged; these travel in straight line from cathode to the anode (A), however in the presence of an external electrical field these bend towards the positive plate (B)

These particles constituting the cathode rays were later called **electrons**. Since it was observed that the nature of cathode rays was the same irrespective of the metal used for the cathode or the gas filled in the cathode ray tube. This led Thomson to



Notes



Notes

conclude that all atoms must contain electrons. *This meant that the atom is not indivisible as was believed by Dalton and others.* In other words, we can say that the Dalton's theory of atomic structure failed partially.

This conclusion raised a question, "If the atom was divisible, then what were its constituents?". Today a number of smaller particles are found to constitute atoms. These particles constituting the atom are called **subatomic particles**. You have learnt above that electron is one of the constituents of the atom, let us study the next section to learn about another constituent particle present in an atom. As the atom is neutral, we expect the presence of positively charged particles in the atom so as to neutralise the negative charge of the electrons.

5.1.2 Discovery of Proton

Much before the discovery of electron, Eugen **Goldstein** (in 1886) performed an experiment using a perforated cathode (a cathode having holes in it) in the discharge tube filled with air at a very low pressure. When a high voltage was applied across the electrodes in the discharge tube, a faint red glow was observed behind the perforated cathode. Fig. 5.3

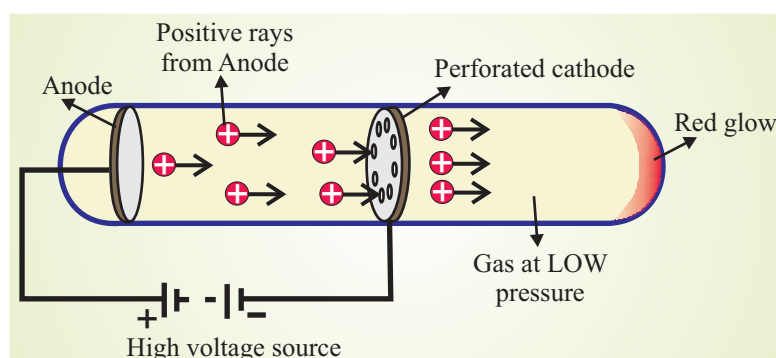

Fig. 5.3 Goldstein's cathode ray tube with perforated cathode

This glow was due to another kind of rays flowing in a direction opposite to that of the cathode rays. These rays were called as **anode rays** or positive rays. These were positively charged and were also called **canal rays** because they passed through the holes or the canals present in the perforated cathode. The following observations were made about anode rays (canal rays):

- Like cathode rays, the anode rays also travel in straight lines.
- The particles constituting anode rays carry mass and have kinetic energy.
- The particles constituting canal rays are much heavier than electrons and carry positive charges

- The positive charge on the particles was whole number multiples of the amount of charge present on the electron.
- The nature and the type of the particles constituting the anode rays were dependent on the gas present in the discharge tube.

The origin of anode rays can be explained in terms of interaction of the cathode rays with the gas present in the vacuum tube. It can be explained as given below:

The electrons emitted from the cathode collide with the neutral atoms of the gas present in the tube and remove one or more electrons present in them. This leaves behind positive charged particles which travel towards the cathode. When the cathode ray tube contained hydrogen gas, the particles of the canal rays obtained were the lightest and their charge to mass ratio (e/m ratio) was the highest. Rutherford showed that these particles were identical to the hydrogen ion (hydrogen atom from which one electron has been removed). These particles were named as **protons** and were shown to be present in all matter. Thus, we see that the experiments by Thomson and Goldstein had shown that an atom contains two types of particle which are oppositely charged and an atom is electrically neutral. What do you think is the relationship between the numbers of these particles in a given atom?

In addition to the two charged particles namely the electron and the proton, a neutral particle called neutron was also discovered about which you would learn later in this lesson. Now, it is the time to check your understanding. For this, take a pause and solve the following intext questions:



INTEXT QUESTIONS 5.1

1. Name two charged particles which constitute all matter.
2. Describe a cathode ray tube.
3. Name the negatively charged particles emitted from the cathode in the cathode ray tube?
4. Why do the canal rays obtained by using different gases have different e/m values?

In addition to the discovery of electrons and protons as the constituents of atom, the phenomenon of **radioactivity** that is the spontaneous emission of rays from atoms of certain elements also proved that the atom was divisible.

5.2 EARLIER MODELS OF ATOM

In section 5.1 you have learnt that the atom is divisible and contains three smaller particles in it. The question that arises is, “In what way are the subatomic particles



Notes



Notes

arranged in the atom?”. On the basis of experimental observations, different models have been proposed for the structure of an atom. In this section, we will discuss two such models namely Thomson model and Rutherford model.

5.2.1 Thomson Model

In lesson 3 you have learnt that all matter is made of atoms and all the atoms are electrically neutral. Having discovered electron as a constituent of atom, Thomson concluded that there must be an equal amount of positive charge present in an atom. On this basis he proposed a model for the structure of atom. According to his model, atoms can be considered as a large sphere of uniform positive charge with a number of small negatively charged electrons scattered throughout it, Fig. 5.4. This model was called as **plum pudding** model. The electrons represent the plums in the pudding made of negative charge. This model is similar to a water-melon in which the pulp represents the positive charge and the seeds denote the electrons. However, you may note that a water melon has a large number of seeds whereas an atom may not have as many electrons.

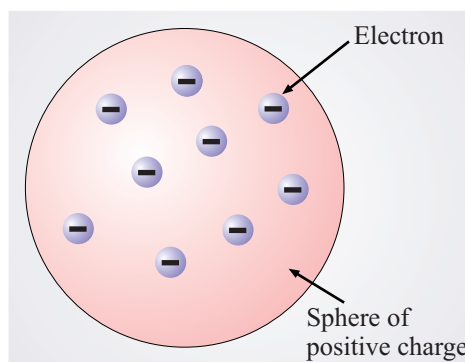

Fig. 5.4: Thomson's plum-pudding model

5.2.2 Rutherford's model

Ernest Rutherford and his co-workers were working in the area of radioactivity. They were studying the effect of alpha (α) particles on matter. The alpha particles are helium nuclei, which can be obtained by the removal of two electrons from the helium atom. In 1910, Hans Geiger (Rutherford's technician) and Ernest Marsden (Rutherford's student) performed the famous α -ray scattering experiment. This led to the failure of Thomson's model of atom. Let us learn about this experiment.

α -Ray scattering experiment

In this experiment a stream of α particles from a radioactive source was directed on a thin (about 0.00004 cm thick) piece of gold foil. On the basis of Thomson's model it was expected that the alpha particles would just pass straight through the

gold foil and could be detected by a photographic plate placed behind the foil. However, the actual results of the experiment, Fig. 5.5, were quite surprising. It was observed that:

- (i) Most of the α -particles passed straight through the gold foil.
- (ii) Some of the α -particles were deflected by small angles.
- (iii) A few particles were deflected by large angles.
- (iv) About 1 in every 12000 particles experienced a rebound.

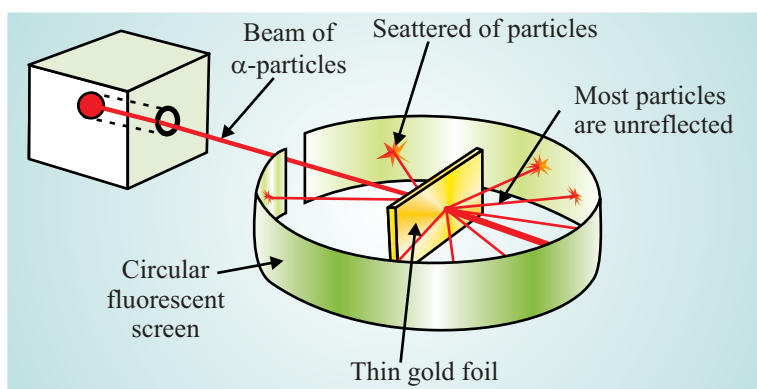

Fig. 5.5: The experimental set-up and observations in the α -ray scattering experiment performed by Geiger and Marsden

The results of α -ray scattering experiment were explained by Rutherford in 1911 and another model of the atom was proposed. According to Rutherford's model, Fig. 5.6(a).

- An atom contains a dense and positively charged region located at its centre; it was called as **nucleus**,
- All the positive charge of an atom and most of its mass was contained in the nucleus,
- The rest of an atom must be empty space which contains the much smaller and negatively charged electrons,

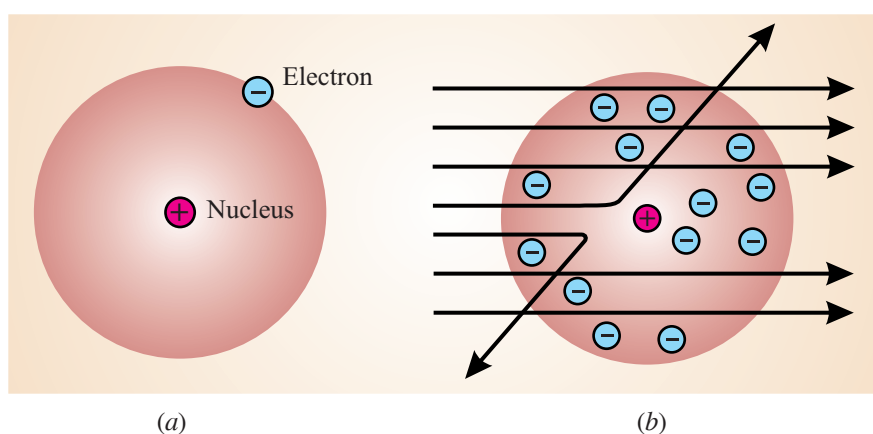

Fig 5.6: (a) Rutherford's model of atom (b) Explanation of the results of scattering experiment by Rutherford's model.



Notes



Notes

On the basis of the proposed model, the experimental observations in the scattering experiment could be explained. This is illustrated in Fig. 5.6(b). The α particles passing through the atom in the region of the electrons would pass straight without any deflection. Only those particles that come in close vicinity of the positively charged nucleus get deviated from their path. Very few α -particles, those that collide with the nucleus, would face a rebound.

On the basis of his model, Rutherford was able to predict the size of the nucleus. He estimated that the radius of the nucleus was at least 1/10000 times smaller than that of the radius of the atom. We can imagine the size of the nucleus with the following analogy. If the size of the atom is that of a cricket stadium then the nucleus would have the size of a fly at the centre of the stadium.



INTEXT QUESTIONS 5.2

1. Describe Thomson's model of atom. What is it called?
2. What would have been observed in the α -ray scattering experiment if the Thomson's model was correct?
3. Who performed the α -ray scattering experiment and what were the observations?
4. Describe the model of atom proposed by Rutherford.

5.3 DRAWBACKS OF RUTHERFORD'S MODEL

According to Rutherford's model the negatively charged electrons revolve in circular orbits around the positively charged nucleus. However, according to Maxwell's electromagnetic theory (about which you may learn in higher classes), if a charged particle accelerates around another charged particle then it would continuously lose energy in the form of radiation. The loss of energy would slow down the speed of the electron. Therefore, the electron is expected to move in a spiral fashion around the nucleus and eventually fall into it as shown in Fig. 5.7. In other words, the atom will not be stable. However, we know that the atom is stable and such a collapse does not occur. Thus, Rutherford's model is unable to explain the stability of the atom. You know that an atom may contain a number of electrons. The Rutherford's model also does not say anything about the way the electrons are distributed around the nucleus. Another drawback of the Rutherford's model was its inability to explain the

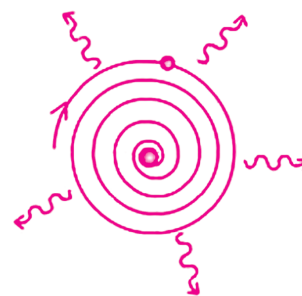

Fig. 5.7: The electron in the Rutherford's model is expected to spiral into the nucleus

relationship between the atomic mass and atomic number (the number of protons). This problem was solved later by Chadwick by discovering neutron, the third particle constituting the atom. You would learn about it in section 5.5.

The problem of the stability of the atom and the distribution of electrons in the atom was solved by Neils Bohr by proposing yet another model of the atom. This is discussed in the next section.

5.4 BOHR'S MODEL OF ATOM

In 1913, Niels Bohr, a student of Rutherford proposed a model to account for the shortcomings of Rutherford's model. Bohr's model can be understood in terms of two postulates proposed by him. The postulates are:

Postulate 1: *The electrons move in definite circular paths of fixed energy around a central nucleus; just like our solar system in which different planets revolve around the Sun in definite trajectory. Similar to the planets, only certain circular paths around the nucleus are allowed for the electrons to move. These paths are called **orbits**, or **energy levels**. The electron moving in the orbit does not radiate. In other words, it does not lose energy; therefore, these orbits are called **stationary orbits** or **stationary states**. The bold concept of stationary state could answer the problem of stability of atom faced by Rutherford's model.*

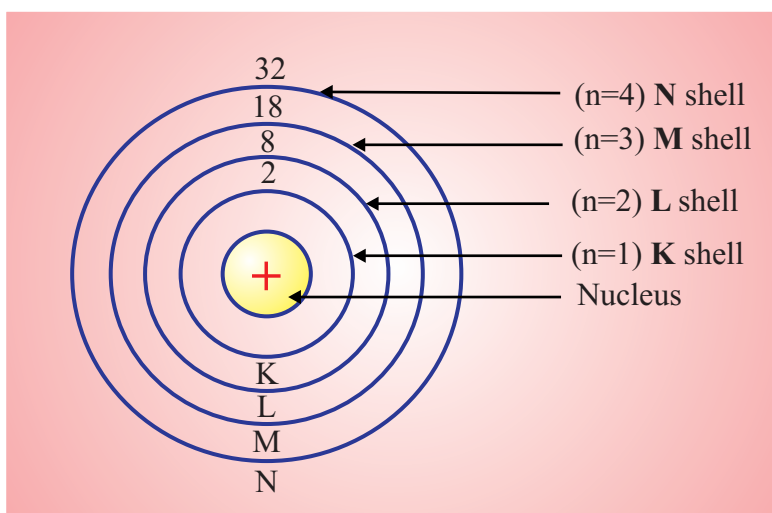

Fig. 5.8: Illustration showing different orbits or the energy levels of fixed energy in an atom according to Bohr's model

It was later realised that the concept of circular orbit as proposed by Bohr was not adequate and it was modified to energy shells with definite energy. While a circular orbit is two dimensional, a shell is a three dimensional region. The shells of definite energy are represented by letters (K, L, M, N etc.) or by positive integers (1, 2, 3, etc.) Fig. 5.8. The energies of the shells increase with the number n ; $n = 1$,



Notes



Notes

level is of the lowest energy. Further, the maximum number of electrons that can be accommodated in each shell is given by $2n^2$, where n is the number of the level. Thus, the first shell ($n=1$) can have a maximum of two electrons whereas the second shell can have 8 electrons and so on. Each shell is further divided into various sublevels called **subshells** about which you would study in your higher classes.

Postulate 2: The electron can change its shells or energy level by absorbing or releasing energy. An electron at a lower state of energy E_i can go to a final higher state of energy E_f by absorbing a single photon of energy given by:

$$E = h\nu = E_f - E_i$$

Similarly, when electron changes its shell from a higher initial level of energy E_i to a lower final level of energy E_f , a single photon of energy $h\nu$ is released (Fig. 5.9).

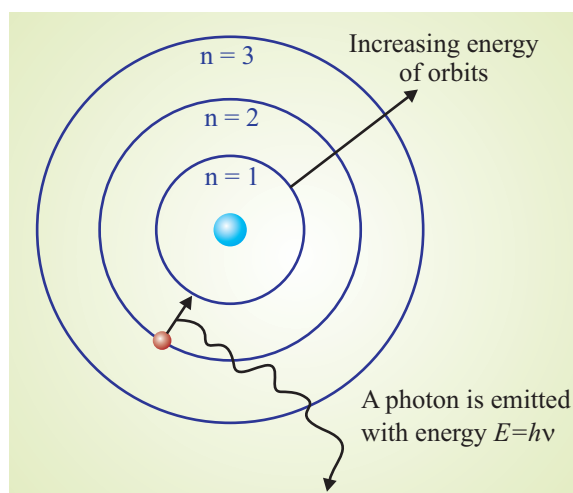

Fig. 5.9: The electrons in an atom can change their energy level by absorbing suitable amounts of energy or by emitting energy.



INTEXT QUESTIONS 5.3

1. Give any two drawbacks of Rutherford's model of atom.
2. State the postulates of Bohr's model.
3. How does Bohr model of an atom explain the stability of the atom?

Thus, the Bohr's model of atom removes two of the limitations of Rutherford's model. These are related to the stability of atom and the distribution of electrons around the nucleus. You would recall that the third limitation of Rutherford's model was its

inability to explain the relationship between the atomic mass, and the atomic number (the number of protons) of an atom. Let us learn how this problem was solved with the discovery of neutron.

5.5 DISCOVERY OF NEUTRON

You would recall that when we discussed about the failure of Rutherford's model we mentioned that it was unable to explain the relationship between the atomic mass and the atomic number (the number of protons). According to the Rutherford's model, the mass of helium atom (containing 2 protons) should be double that of a hydrogen atom (with only one proton). [Ignoring the mass of electron as it is very light]. However, the actual ratio of the masses of helium atom to hydrogen atom is 4:1. It was suggested that there must be one more type of subatomic particle present in the nucleus which may be neutral but have mass.

Such a particle was discovered by James Chadwick in 1932. This was found to be electrically neutral and was named **neutron**. Neutrons are present in the nucleus of all atoms, except hydrogen. A neutron is represented as 'n' and is found to have a mass slightly higher than that of a proton. Thus, if the helium atom contained 2 protons and 2 neutrons in the nucleus, the mass ratio of helium to hydrogen (4:1) could be explained. The characteristics of the three fundamental particles constituting the atom are given in Table 5.1.

Table 5:1 Characteristics of the fundamental subatomic particles

Particle	Symbol	Mass (in kg)	Actual Charge (in Coulombs)	Relative charge
Electron	e	$9.109\ 389 \times 10^{-31}$	$1.602\ 177 \times 10^{-19}$	-1
Proton	p	$1.672\ 623 \times 10^{-27}$	$1.602\ 177 \times 10^{-19}$	1
Neutron	n	$1.674\ 928 \times 10^{-27}$	0	0



INTEXT QUESTIONS 5.4

1. What is a neutron and where is it located in the atom?
2. How many neutrons are present in the α -particle?
3. How will you distinguish between an electron and a proton?

5.6 ATOMIC NUMBER AND MASS NUMBER

You have learnt that the nucleus of atom contains positively charged particles called protons and neutral particles called neutrons. **The number of protons in an atom is called the atomic number and is denoted by the symbol 'Z'**. All atoms of an



Notes



Notes

element have the same atomic number. The electrons occupy the space outside the nucleus. In order to account for the electrically neutral nature of the atom, the number of protons in the nucleus is exactly equal to the number of electrons. Thus,

$$\text{Atomic number} = \text{number of protons} = \text{number of electrons}$$

You would recall that according to Dalton's theory, the atoms of different elements are different from each other. We can now say that this difference is due to difference in the numbers of protons present in the nucleus of the element. In other words, different elements differ in terms of their **atomic number**. For example, the atoms of hydrogen and helium are different because hydrogen has one proton in its nucleus whereas the nucleus of helium atom contains two protons. Their atomic numbers are 1 and 2, respectively. You have learnt in the Rutherford's model that the mass of the atom is concentrated in its nucleus. This is due to the presence of two heavy particles namely protons and neutrons in the nucleus. These particles are called **nucleons**. *The number of nucleons in the nucleus of an atom is called its mass number*. It is denoted by 'A' and is equal to the total number of protons and neutrons present in the nucleus of an element. Thus,

$$\text{Mass number (A)} = \text{number of protons(Z)} + \text{number of neutrons(n)}$$

Atomic number and mass number are represented on the symbol of an element. An element, X with an atomic number, Z and the mass number, A is denoted as follows:



For example, ${}^{12}_6\text{C}$ means that the carbon has an atomic number of 6 and the mass number of 12. This can be used to compute the number of different fundamental particles in the atom. Let us calculate it for carbon.

As the atomic number is 6 this means:

Number of protons = number of electrons = 6

As Mass number = number of protons + number of neutrons

$$\Rightarrow 12 = 6 + \text{number of neutrons}$$

$$\Rightarrow \text{number of neutrons} = 12 - 6 = 6$$

Thus, an atom of ${}^{12}_6\text{C}$ has 6 protons, 6 electrons and 6 neutrons.



INTEXT QUESTIONS 5.5

1. A sodium atom has an atomic number of 11 and a mass number of 23. Calculate the number of protons, electrons and neutrons in a sodium atom.

- What is the mass number of an atom which has 7 protons and 8 neutrons?
- Calculate the number of electrons, protons and neutrons in ${}_{18}^{40}\text{Ar}$ and ${}_{19}^{49}\text{K}$.

5.7 ELECTRONIC CONFIGURATION: DISTRIBUTION OF ELECTRONS IN DIFFERENT ORBITS

As discussed in section 5.4, the electrons move in definite paths called orbits or shells around a central nucleus. These orbits or shells have different energies and can accommodate different number of electrons in them. The question arises that how are the electrons distributed amongst these shells? The answer to this question was provided by Bohr and Bury. According to their scheme, the electron distribution is governed by the following rules:

- These orbits or shells in an atom are represented by the letters K, L, M, N, ... or the positive integral numbers, $n = 1, 2, 3, 4, \dots$
- The orbits are arranged in the order of increasing energy. The energy of M shell is more than that of the L shell which in turn is more than that of the K shell.
- The maximum number of electrons present in a shell is given by the formula $2n^2$, where 'n' is the number of the orbit or the shell. Thus, the maximum number of electrons that can be accommodated in different shells are as follows:

$$\text{Maximum number of electrons in K shell (or } n = 1 \text{ level)} = 2n^2 = 2 \times (1)^2 = 2$$

$$\text{Maximum number of electrons in L shell (or } n = 2 \text{ level)} = 2n^2 = 2 \times (2)^2 = 8$$

$$\text{Maximum number of electrons in M shell (or } n = 3 \text{ level)} = 2n^2 = 2 \times (3)^2 = 18 \text{ and so on. See table 5.2}$$

Table 5.2: Electron accommodation capacity of different shells

Value of n	Shell name	Maximum capacity
1	K-Shell	2
2	L-Shell	8
3	M-Shell	18
4	N-Shell	32

- The shells are occupied in the increasing order of their energies.
- Electrons are not accommodated in a given shell, unless the inner shells are completely filled.

The arrangement of electrons in the various shells or orbits of an atom of the element is known as electronic configuration. Keeping these points in mind, let us now study the filling of electrons in various shells of atoms of different elements.



Notes



Notes

- Hydrogen (H) atom has only one electron. It would occupy the first shell and electronic configuration of hydrogen can be represented as 1.
- The next element helium (He) has two electrons in its atom. Since the first shell can accommodate two electrons; hence, this second electron will also be placed in the first shell. The electronic configuration of helium is written as 2.
- The third element, Lithium (Li) has three electrons. Now the two electrons occupy the first shell whereas the third electron goes to the next shell of higher energy level, i.e. second shell. Thus, the electronic configuration of Li is 2, 1.

Similarly, the electronic configurations of other elements can be written. The structures of the atoms of elements with atomic number 1 to 18 are given in Fig. 5.10.

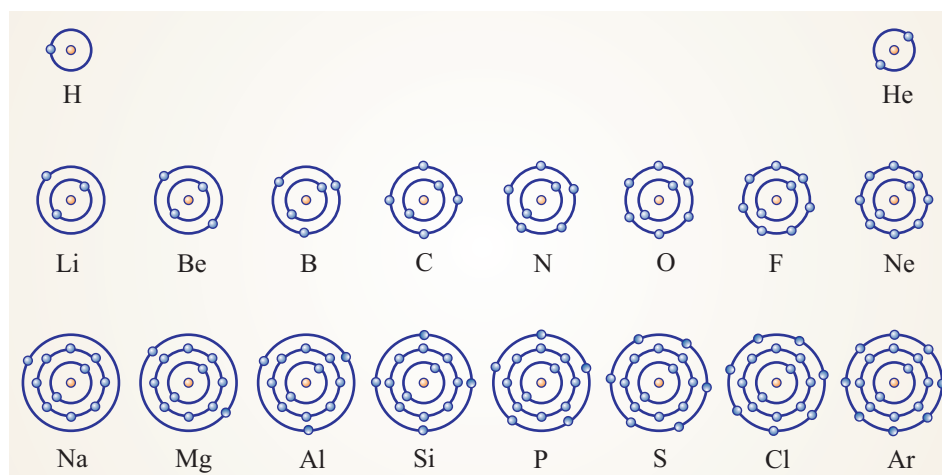

Fig. 5.10: The structures, according to Bohr's model of atoms, of elements with atomic number 1 to 18.

5.7.1 Concept of Valence or Valency

We have just discussed the electronic configuration of first 18 elements. You can see from the Fig. 5.10 that different elements have different number of electrons in the outermost or the valence shell. These electrons in the outermost shell are known as valence electrons. **The number of valence electrons determines the combining capacity of an atom in an element.** Valence is the number of chemical bonds that an atom can form with univalent atoms. Since hydrogen is a univalent atom, the valence of an element can be taken by the number of atoms of hydrogen with which one atom of the element can combine. For example, in H_2O , NH_3 , and CH_4 the valencies of oxygen, nitrogen and carbon are 2, 3 and 4 respectively.

The elements having a completely filled outermost shell in their atoms show little or no chemical activity. In other words, their combining capacity or valency is zero. The elements with completely filled valence shells are said to have stable electronic

configuration. The main group elements can have a maximum of eight electrons in their valence shell. This is called **octet rule**; you will learn more about it in lesson 7. You will learn that the combining capacity or the tendency of an atom to react with other atoms to form molecules depends on the ease with which it can achieve octet in its outermost shell. The valencies of the elements can be calculated from the electronic configuration by applying the octet rule. It can be seen as follows:

- If the number of valence electrons is four or less then the valency is equal to the number of the valence electrons.
- In cases when the number of valence electrons is more than four then generally the valency is equal to 8 minus the number of valence electrons.

Thus,

Valency = Number of valence electrons (for 4 or lesser valence electrons)

Valency = 8 - Number of valence electrons (for more than 4 valence electrons)

The composition and electronic configuration of the elements having the atomic numbers from 1 to 18, along with their valencies is given in Table 5.3.

Table 5.3: The composition, electron distribution and common valency of the elements with atomic number from 1 to 18

Name of Element	Symbol	Atomic Number	Number of Protons	Number of Neutrons	Number of Electrons	Distribution of Electrons				Valency
						K	L	M	N	
Hydrogen	H	1	1	–	1	1	–	–	–	1
Helium	He	2	2	2	2	2	–	–	–	0
Lithium	Li	3	3	4	3	2	1	–	–	1
Beryllium	Be	4	4	5	4	2	2	–	–	2
Boron	B	5	5	6	5	2	3	–	–	3
Carbon	C	6	6	6	6	2	4	–	–	4
Nitrogen	N	7	7	7	7	2	5	–	–	3
Oxygen	O	8	8	8	8	2	6	–	–	2
Fluorine	F	9	9	10	9	2	7	–	–	1
Neon	Ne	10	10	10	10	2	8	–	–	0
Sodium	Na	11	11	12	11	2	8	1	–	1
Magnesium	Mg	12	12	12	12	2	8	2	–	2
Aluminium	Al	13	13	14	13	2	8	3	–	3
Silicon	Si	14	14	14	14	2	8	4	–	4
Phosphorus	P	15	15	16	15	2	8	5	–	3, 5
Sulphur	S	16	16	16	16	2	8	6	–	2
Chlorine	Cl	17	17	18	17	2	8	7	–	1
Argon	Ar	18	18	22	18	2	8	8	–	0



Notes



Notes

In next lesson, you will study about the importance of electronic configurations in understanding the periodic arrangement of elements. These electronic configurations are also helpful in studying the nature of bonding between various elements which will be dealt with in lesson 7.



INTEXT QUESTIONS 5.6

1. How many shells are occupied in the nitrogen (atomic number =7) atom?
2. Name the element which has completely filled first shell.
3. Write the electronic configuration of an element having atomic number equal to 11.



WHAT HAVE YOU LEARNT

- According to Dalton's atomic theory, the atom is considered to be the smallest indivisible constituent of all matter. This theory could explain the law of conservation of mass, law of constant composition and law of multiple proportions. However, certain experiments towards the end of nineteenth century showed that the atom is neither the smallest nor indivisible particle of matter. It was shown to be made up of even smaller particles called electrons, protons and neutrons.
- Sir J.J. Thomson discovered that when very high voltage was passed across the electrodes in the cathode ray tube, the cathode produced rays that travel from cathode to anode and were called **cathode rays**. It showed that the rays were made up of a stream of negatively charged particles called electrons. The discovery of electrons *meant that the atom is not indivisible as was believed by Dalton and others*.
- Eugen **Goldstein** discovered anode rays by using a perforated cathode (a cathode having holes in it) in the discharge tube filled with air at a very low pressure. The discovery of anode rays established the presence of positively charged proton in the atom.
- According to Thomson's plum-pudding model, atoms can be considered as a large sphere of uniform positive charge with a number of small negatively charged electrons scattered throughout it.
- The α -ray scattering experiment performed by Geiger and Marsden led to the failure of Thomson's model of atom. In this experiment, a stream of α -particles from a radioactive source was directed on a thin piece of gold foil. Most of the α -particles passed straight through the gold foil, some α -particles were deflected by small angles, a few particles by large angles and very few experienced a rebound.



Notes

- The results of α -ray scattering experiment were explained in terms of Rutherford's model. According to which the atom contains a dense and positively charged region called **nucleus** at its centre and the negatively charged electrons move around it. All the positive charge and most of the mass of atom is contained in the nucleus.
- The Rutherford's model however failed as it could not explain the stability of the atom, the distribution of electrons and the relationship between the atomic mass and atomic number (the number of protons).
- The problem of the stability of the atom and the distribution of electrons in the atom was solved by Neils Bohr in terms of Bohr's model of the atom. Bohr's model can be understood in terms of two postulates, the first being, '*The electrons move in definite circular paths of fixed energy around a central nucleus*' and the second, '*The electron can change its orbit or energy level by absorbing or releasing energy.*'
- In 1932, James Chadwick discovered an electrically neutral particle in atom and named it as **neutron**.
- The number of protons in an atom is called the atomic number and is denoted as 'Z'. On the other hand the number of nucleons(protons plus neutrons) in the nucleus of an atom is called its mass number and is denoted as 'A'
- The electrons are distributed in different shells in the order of increasing energy. The distribution is called electronic configuration. The maximum number of electrons present in a shell is given by the formula $2n^2$, where 'n' is the number of the orbit or the shell.
- The valence is the number of chemical bonds that an atom can form with univalent atoms. If the number of valence electrons is four or less, then the valency is equal to the number of the valence electrons. On the other hand, if the number of valence electrons is more than four, then generally the valency is equal to 8 minus the number of valence electrons.

**TERMINAL EXERCISE**

1. How did J.J.Thomson discover the electron? Explain his "plum pudding" model of the atom.
2. What made Thomson conclude that all atoms must contain electrons?
3. Identify the following subatomic particles:
 - (a) The number of these in the nucleus is equal to the atomic number
 - (b) The particle that is not found in the nucleus
 - (c) The particle that has no electrical charge
 - (d) The particle that has a much lower mass than the others subatomic particles



Notes

4. Which of the following are usually found in the nucleus of an atom?
 - (a) Protons and neutrons only
 - (b) Protons, neutrons and electrons
 - (c) Neutrons only
 - (d) Electrons and neutrons only
5. Describe Ernest Rutherford's experiment with alpha particles and gold foil. How did this lead to the discovery of the nucleus?
6. What does the atomic number tell us about an atom?
7. What is the relationship between the numbers of electrons and protons in an atom?
8. How did Neils Bohr revise Rutherford's atomic model?
9. What is understood by a stationary state?
10. What is a shell? How many electrons can be accommodate in L-shell?
11. State the rules for writing the electronic configuration of elements.



ANSWERS TO INTEXT QUESTIONS

5.1

1. Electrons and protons
2. A cathode ray tube consists of two metal electrodes in a partially evacuated glass tube. The negatively charged electrode is called cathode while the positively charged electrode is called anode. These electrodes are connected to a high voltage source.
3. Electron
4. When the electrons emitted from the cathode collide with the neutral atoms of the gas present in the tube, these remove one or more electrons present in them. This leaves behind positive charged particles which travel towards the cathode. As the atoms of different gases have different number of protons present in them, these give positively charged ions with different e/m values.

5.2

1. According to Thomson's model, atoms can be considered as a large sphere of uniform positive charge with a number of small negatively charged electrons scattered throughout it. This model was called as **plum pudding** model.



Notes

2. If the Thomson's model was correct, then most of the α -particles in the α -ray scattering experiment would have passed straight through the atom
3. The α -ray scattering experiment was performed by Geiger and Marsden. When a stream of α -particles from a radioactive source was directed on a thin piece of gold foil, most of the α -particles passed straight through the gold foil, some α -particles were deflected by small angles, a few particles by large angles and very few experienced a rebound.
4. According to Rutherford's model, the atom contains a dense and positively charged region called **nucleus** at its centre and the negatively charged electrons move around it. All the positive charge and most of the mass of atom is contained in the nucleus.

5.3

1. The Rutherford's model could not explain the stability of the atom, the distribution of electrons and the relationship between the atomic mass and atomic number (the number of protons).
2. The two postulates of Bohr's model are :
 - I. The electrons move in definite circular paths of fixed energy around a central nucleus.
 - II. The electron can change its orbit or energy level by absorbing or releasing energy.
3. The Bohr's model explains the stability of atom by proposing that the electron does not lose energy when present in a given energy level.

5.4

1. It is a neutral subatomic particle present in the nucleus of the atom.
2. An α -particle contains two neutrons.
3. The electron and proton can be distinguished in terms of their charge and mass. While the electron is negatively charged, the proton is positively charged. Secondly, the proton is much heavier than the electron; it is about 1840 times heavier.

5.5

1. No of protons = 11
No. of electrons = 11
No. of neutrons = 12



Notes

2. Mass number = number of protons + number of neutrons

Therefore, mass number = $7 + 8 = 15$

3. ${}_{18}^{40}\text{Ar}$: Number of protons = atomic number = 18

Number of electrons = number of protons = 18

Number of neutrons = mass number – number of protons = $40 - 18 = 22$

- ${}_{19}^{40}\text{K}$: Number of protons = atomic number = 19

Number of electrons = number of protons = 19

Number of neutrons = mass number – number of protons = $40 - 19 = 21$

5.6

1. The electronic configuration of nitrogen is 2, 5. Thus, two shells are occupied. The first shell (capacity = 2) is completely filled while the second shell (capacity = 8) is partially filled.
2. Helium
3. The electronic configuration of an element having atomic number 11 is 2, 8, 1.



6

PERIODIC CLASSIFICATION OF ELEMENTS

In the last lesson, you have studied about the structure of atoms and their electronic configurations. You have also learnt that the elements with similar electronic configurations show similar chemical properties. By the middle of the nineteenth century quite a large number of elements (nearly 60) were known. In order to study these elements systematically, it was considered necessary to classify them. In this lesson, you will undertake the journey through the development of classification of elements from ancient to modern. You will also study how some properties of elements vary in the modern periodic table.



OBJECTIVES

After studying this lesson you will be able to:

- describe briefly the development of classification of elements;
- state main features of Mendeleev's periodic table;
- explain the defects of Mendeleev's periodic table;
- state modern periodic law;
- describe the features of the long form of periodic table;
- explain modern periodic classification and
- describe the trends in variation of atomic size and metallic character in the periodic table.

6.1 CLASSIFICATION OF ELEMENTS

6.1.1 Need for Classification of Elements

You must have visited a chemist's shop. Several hundred medicines are stored in it. In spite of this, when you ask for a particular medicine, the chemist is able to locate it easily. How is it possible? It is because the medicines have been *classified* into various categories and sub categories and arranged accordingly. This makes their location an easy task.



Before the beginning of the eighteenth century, only a few elements were known, so it was quite easy to study and remember the properties of those elements and their compounds individually. However, by the middle of the nineteenth century, more than sixty elements had been discovered. The number of compounds formed by them was also enormous. With the increasing number of elements, it was becoming more and more difficult to study their properties individually. Therefore, the need for their classification was felt. This led to the classifications of various elements into groups which helped in the systematic study of elements.

6.1.2 Development of Classification

Scientists after many attempts were successful in arranging various elements into groups. They realised that even though every element is different from others, yet there are a few similarities among some elements. Accordingly, similar elements were arranged into groups which led to classification. Various types of classification were proposed by different scientists. The first classification of elements was into 2 groups – **metals** and **non-metals**. This classification served only limited purpose mainly because some elements like germanium and antimony showed the properties of both – metals and non-metals. They could not be placed in any of the two classes.

Scientists were in search of such characteristics of an element which would never change. After the work of William Prout in 1815, it was found that the atomic mass of an element remains constant, so it could form the basis for a satisfactory classification. Now, you will learn about the *four* major attempts made for classification of elements. They are as follows :

1. Dobereiner's Triads
2. Newlands' Law of Octaves
3. Mendeleev's Periodic Law & Periodic Tables
4. Modern Periodic Table

6.1.3 Dobereiner's Triads

In 1829, J.W. Dobereiner, a German chemist made groups of three elements each and called them **triads** (Table 6.1). All three elements of a triad were similar in their physical and chemical properties. He proposed a law known as **Dobereiner's law of triads**. According to this law, *when elements are arranged in order of increasing atomic mass, the atomic mass of the middle element was nearly equal to the arithmetic mean of the other two and its properties were intermediate between those of the other two.*



J.W. Dobereiner
(1780-1849)

Table 6.1: Dobereiner's triads of elements

S. No.	Element	Atomic Mass	Mean of I and III
1.	I. Lithium II. Sodium III. Potassium	7 23 39	$\frac{7+39}{2} = 23$
2.	I. Calcium II. Strontium III. Barium	40 88 137	$\frac{40+137}{2} = 88.5$
3.	I. Chlorine II. Bromine III. Iodine	35.5 80 127	$\frac{35.5+127}{2} = 81.25$

This classification did not receive wide acceptance since only a few elements could be arranged into triads.

6.1.4 Newlands' Law of Octaves

In 1864, an English chemist John Alexander Newlands arranged the elements in the increasing order of their atomic masses (then called *atomic weight*). He observed that *every eighth element had properties similar to the first element*. Newlands called it the **Law of Octaves**. It was due to its similarity with musical notes where every eighth note is the repetition of the first one as shown below :

1	2	3	4	5	6	7	8
सा	रे	गा	मा	पा	धा	नी	सा

The arrangement of elements given by Newlands is given in Table 6.2.

Starting from *lithium* (Li), the eighth element is *sodium* (Na) and its properties are similar to those of the lithium. Similarly, *beryllium* (Be), *magnesium* (Mg) and *calcium* (Ca) show similar properties. *Fluorine* (F) and *chlorine* (Cl) are also similar chemically.

Table 6.2 : Arrangement of some elements with their atomic masses according to the Law of Octaves.

Li	Be	B	C	N	O	F
(7)	(9)	(11)	(12)	(14)	(16)	(19)
Na	Mg	Al	Si	P	S	Cl
(23)	(24)	(27)	(28)	(31)	(32)	(35.5)
K	Ca					
(39)	(40)					

The **merits of Newlands'** Law of Octaves classification are:

- (i) Atomic mass was made the basis of classification.



Notes



Notes

- (ii) Periodicity of properties (the repetition of properties after a certain interval) was recognised for the first time.

The demerits of Newlands' law of Octaves are:

- (i) It was not applicable to elements of atomic masses higher than 40 u. Hence, all the 60 elements known at that time, could not be classified according to this criterion.
- (ii) With the discovery of noble gases, it was found that it was the *ninth* element which had the properties similar to the first one and *not the eighth* element. This resulted in the rejection of the very idea of octaves.

The basic idea of Newlands for using the atomic mass as the fundamental property for classification of elements was pursued further by two scientists Lothar Meyer and D. Mendeleev. Their main achievement was that they both included almost all the known elements in their work. We shall, however, discuss the classification proposed by Mendeleev which was accepted more widely and is the basis of the modern classification.

6.1.5 Mendeleev's Periodic Law and Periodic Table

D'mitri Mendeleev (also spelled as Mendeleef or Mandelevey), a Russian chemist studied the properties of all the 63 elements known at that time and their compounds. On arranging the elements in the increasing order of atomic masses, he observed that the elements with similar properties occur periodically. In 1869, he stated this observation in the form of the following statement which is known as the **Mendeleev's Periodic Law**.

The chemical and physical properties of elements are a periodic function of their atomic masses.

A *periodic function* is the one which repeats itself after a certain interval. Mendeleev arranged the elements in the form of a table which is known as the **Mendeleev's Periodic Table**.

Mendeleev's Periodic Table

Mendeleev arranged the elements in the increasing order of their atomic masses in horizontal rows till he came across an element whose properties were similar to those of the first element. Then he placed this element below the first element and thus started the second row of elements.

The success of Mendeleev's classification was due to the fact that he laid more emphasis on the properties of elements rather than on atomic masses. Occasionally, he could not find an element that would fit in a particular position. He left such positions vacant for the elements that were yet to be discovered. He even predicted the properties of such elements and of some of their compounds fairly accurately. In some cases, he even reversed the order of some elements, if it better



D. Mendeleev
(1834-1907)

matched their properties. Proceeding in this manner, he could arrange all the known elements in his periodic table.

When more elements were discovered, this periodic table was modified and updated to include them. One more group (zero group) had to be added when noble gases were discovered.



Notes

Table 6.3: Mendeleev's updated periodic table

Groups	I		II		III		IV		V		VI		VII		VIII				
Oxides	RO		RO		R ₂ O ₃		RO ₂		R ₂ O ₃		RO ₃		R ₂ O ₇		RO ₄				
Hydrides	RH		RH ₂		RH ₃		RH ₄		RH ₃		RH ₂		RH						
Periods ↓	A	B	A	B	A	B	A	B	A	B	A	B	A	B	Transition series				
1	H 1.008																		
2	Li 6.939		Be 9.012		B 10.81		C 12.011		N 14.007		O 15.999		F 18.998						
3	Na 22.99		Mg 24.31		Al 29.98		Si 28.09		P 30.974		S 32.06		Cl 35.453						
4 First series:	K 39.102		Ca 40.08		Sc 44.96		Ti 47.90		V 50.94		Cr 50.20		Mn 54.94		Fe 55.85		Co 58.93		Ni 58.71
Second series:	Cu 63.54		Zn 65.37		Ga 69.72		Ge 72.59		As 74.92		Se 78.96		Br 79.909						
5 First series:	Rb 85.47		Sr 87.62		Y 88.91		Zr 91.22		Nb 92.91		Mo 95.94		Tc 99		Ru 101.07		Rh 102.91		Pd 106.4
Second series:	Ag 107.87		Cd 112.40		In 114.82		Sn 118.69		Sb 121.75		Te 127.60		I 126.90						
6 First series:	Cs 132.90		Ba 137.34		La 138.91		Hf 178.49		Ta 180.95		W 183.85				Os 190.2		Ir 192.2		Pt 195.09
Second series:	Au 196.97		Hg 200.59		Tl 204.37		Pb 207.19		Bi 208.98										

Main Features of Mendeleev's Periodic Table

The following are the main features of this periodic table :

1. The elements are arranged in **rows** and **columns** in the periodic table.
2. The horizontal rows are called periods. There are six periods in the periodic table. These are numbered from 1 to 6 (Arabic numerals). Each one of the 4th, 5th and 6th periods have two series of elements.
3. Properties of elements in a given period show regular gradation (*i.e.* increase or decrease) from left to right.
4. The vertical columns present in it are called **groups**. There are eight groups numbered from **I** to **VIII** (Roman numerals).
5. Groups I to VII are further divided into A and B **subgroups**. However, group VIII contains three elements in each of the three periods.
6. All the elements present in a particular group are chemically similar in nature. They also show a regular gradation in their physical and chemical properties from top to bottom.

Merits of Mendeleev's Periodic Classification

1. Classification of all elements

Mendeleev's classification included *all the 63 elements known* at that time on the basis of their atomic mass and facilitated systematic study of elements.



Notes

2. Correction of atomic masses

Atomic masses of some elements like Be (*beryllium*), Au (*gold*), In (*indium*) were corrected based on their positions in the table. (See box 1)

3. Prediction of new elements

Mendeleev arranged the elements in the periodic table in increasing order of atomic mass but whenever he could not find out an element with expected properties, he left a blank space. He left this space blank for an element yet to be discovered. He even predicted the properties of such elements and also of some of their compounds. For example, he predicted the existence of unknown element for the vacant space below silicon and thus belonging to the same group IV B, of the periodic table. He called it **eka-silicon** (meaning, *one position below silicon*). Later, in 1886, *C.A. Winkler* of Germany discovered this element and named it as **germanium**. The predicted and the actual properties of this element were remarkably similar (see Box 2). **Ekaboron** (scandium) and **eka-aluminium** (gallium) are two more examples of unknown elements predicted by Mendeleev.

Box 1

Indium had been assigned an atomic mass of 76 and valency of *two*. On the basis of its position in the periodic table, Mendeleev predicted its atomic mass to be 113.1 and its valency to be *three*. The accepted atomic mass today is 114.82 and valency is *three*.

Box 2

Predictions for eka-silicon by Mendeleev

Property	Predicted eka-silicon	Actual Germanium
Atomic Mass	72	72.6
Density/g cm ⁻³	5.5	5.36
Melting point	High	1231K
Action of acid	Likely to be slightly attacked	No action with HCl, reacts with hot nitric acid
Action of alkali	No reaction	No action with dil. NaOH
Oxide	MO ₂	GeO ₂
Sulphide	MS ₂	GeS ₂
Chloride	MCl ₄	GeCl ₄
Boiling point of chloride	373 K	356 K

4. Valency of elements

Mendeleev's classification helped in understanding the valency of elements. The valency of elements is given by the group number. For example, all the elements in group 1 i.e. lithium, hydrogen, sodium, potassium, rubidium, caesium have valency 1.

Defects of Mendeleev's Periodic Table

Mendeleev's periodic table was a great success, yet it had the following defects :

1. Position of Hydrogen

The position of hydrogen which is placed in group IA along with alkali metals is ambiguous as it resembles alkali metals as well as halogens (group VII A).

2. Position of Isotopes

All the isotopes of an element have different atomic masses therefore, each one of them should have been assigned a separate position. On the other hand, they are all chemically similar; hence they should all be placed at the same position. In fact, Mendeleev's periodic table did not provide any space for different isotopes. For example, two isotopes of carbon are represented as ${}_6\text{C}^{12}$, ${}_6\text{C}^{14}$ but placed at the same position.

3. Anomalous* Pairs of Elements

At some places, an element with greater atomic mass had been placed before an element with lower atomic mass due to their properties. For example, cobalt with higher atomic mass (58.9) was placed before nickel with lower atomic mass (58.7). Other such pairs are :

- (i) Tellurium (127.6) is placed before iodine (126.9) and
- (ii) Argon (39.9) is placed before potassium (39.1).

4. Grouping of chemically dissimilar elements

Elements such as copper and silver have no resemblance with alkali metals (lithium, sodium etc.), but have been grouped together in the first group.

5. Separation of chemically similar elements

Elements which are chemically similar such as gold and platinum have been placed in separate groups.

**INTEXT QUESTIONS 6.1**

- Elements A, B and C constitute a Dobereiner's triad. The atomic mass of A is 20 and that of C is 40. Predict the atomic mass of B.
- Which property of atoms was used by Mendeleev to classify the elements?
- In Mendeleev's periodic classification, whether chemically similar elements are placed in a group or in a period?

*Anomaly means deviation from common rule, irregularity, abnormal, exception



Notes



Notes

4. Mendeleev's periodic table had some blank spaces. What did they signify?
5. Explain any three defects of Mendeleev's periodic table.

6.2 MODERN PERIODIC LAW

Though Mendeleev's periodic table included all the elements, yet at many places a heavier element had to be placed before a lighter one. Such pairs of elements (*called anomalous pairs*) violated the periodic law. Also, there was no place for different isotopes of an element in the periodic table. Due to these reasons, it was felt that the arrangement of elements in the periodic table should be based on some other property which is more fundamental than the atomic mass.

In 1913, Henry Moseley, an English physicist discovered that the **atomic number** and not the atomic mass is the most fundamental property of an element.

Atomic number (Z) of an element is the number of protons in the nucleus of its atom.

Since atom is an electrically neutral entity, the number of electrons is also equal to its atomic number i.e. the number of protons. After this development, it was felt necessary to change the periodic law and modify the periodic table.

6.2.1 Modern Periodic Law

The Modern Periodic Law states that the chemical and physical properties of elements are periodic functions of their atomic numbers i.e. if elements are arranged in the order of their increasing atomic number, the elements with similar properties are repeated after certain regular intervals.

Fortunately, even with the revised periodic law, the Mendeleev's classification did not require any major revision as it was based on properties of the elements. In fact, taking atomic number as the basis for classification, removed major defects from it such as *anomalous pairs* and *position of isotopes*.

After changes in the periodic law, many modifications were suggested in the periodic table. Now, we shall learn about the modern periodic table in its final shape that is being used now..

Cause of Periodicity

Let us now understand the cause of periodicity in the properties of elements. Consider the electronic configuration of alkali metals *i.e.*, the first group elements with atomic numbers 3, 11, 19, 37, 55 and 87 (*i.e.*, lithium, sodium, potassium, rubidium, caesium and francium) in the table given below:

Table 6.4 : Electronic configuration of group 1 elements

Element	Electronic configuration
${}_3\text{Li}$	2, 1
${}_{11}\text{Na}$	2, 8, 1
${}_{19}\text{K}$	2, 8, 8, 1
${}_{37}\text{Rb}$	2, 8, 18, 8, 1
${}_{55}\text{Cs}$	2, 8, 18, 18, 8, 1
${}_{87}\text{Fr}$	2, 8, 18, 32, 18, 8, 1

All these elements have one electron in the outer most shell and so they have similar properties which are as follows :

- (i) They are good reducing agents.
- (ii) They form monovalent cations.
- (iii) They are soft metals.
- (iv) They are very reactive and, therefore, found in nature in combined state.
- (v) They impart colour to the flame.
- (vi) They form hydrides with hydrogen.
- (vii) They form basic oxides with oxygen.
- (viii) They react with water to form metal hydroxides and liberate hydrogen.

It is noticed that all the elements having similar electronic configuration have similar properties. Thus, *the re-occurrence of similar electronic configuration is the cause of periodicity in properties of elements.*

6.3 MODERN PERIODIC TABLE

The periodic table based on the modern periodic law is called the **Modern Periodic Table**. Presently, the accepted modern periodic table is the **Long Form of Periodic Table**.

It may be regarded as an extended form of Mendeleev's table in which the sub-groups A and B have been separated.

Now, you will learn the main features of the long form of periodic table which is shown in Table 6.5.



Notes



Notes

Table 6.5 : Modern Periodic Table

Group →	1	2	3	4	5	6	7	8	9	10	11	12	13	14	15	16	17	18
↓ Period	I	II											III	IV	V	VI	VII	VIII
1	hydrogen 1 H																fluorine 9 F	helium 2 He
2	lithium 3 Li	beryllium 4 Be														oxygen 8 O	neon 10 Ne	
3	sodium 11 Na	magnesium 12 Mg														sulfur 16 S	chlorine 17 Cl	argon 18 Ar
4	potassium 19 K	calcium 20 Ca	scandium 21 Sc	titanium 22 Ti	vanadium 23 V	chromium 24 Cr	manganese 25 Mn	iron 26 Fe	cobalt 27 Co	nickel 28 Ni	copper 29 Cu	zinc 30 Zn	gallium 31 Ga	germanium 32 Ge	arsenic 33 As	selenium 34 Se	bromine 35 Br	krypton 36 Kr
5	rubidium 37 Rb	strontium 38 Sr	yttrium 39 Y	zirconium 40 Zr	niobium 41 Nb	molybdenum 42 Mo	technetium 43 Tc	ruthenium 44 Ru	rhodium 45 Rh	palladium 46 Pd	silver 47 Ag	cadmium 48 Cd	indium 49 In	tin 50 Sn	antimony 51 Sb	tellurium 52 Te	iodine 53 I	xenon 54 Xe
6	caesium 55 Cs	barium 56 Ba	lanthanum 57 La	hafnium 72 Hf	tantalum 73 Ta	tungsten 74 W	rhenium 75 Re	osmium 76 Os	iridium 77 Ir	platinum 78 Pt	gold 79 Au	mercury 80 Hg	thallium 81 Tl	lead 82 Pb	bismuth 83 Bi	polonium 84 Po	astatine 85 At	radon 86 Rn
7	francium 87 Fr	radium 88 Ra	actinium 89-103 Ac	rutherfordium 104 Rf	dubnium 105 Db	seaborgium 106 Sg	bohrium 107 Bh	hassium 108 Hs	meitnerium 109 Mt	darmstadtium 110 Ds	roentgenium 111 Rg	unnilbium 112 Uub	unniltrium 113 Uut	unnilquadium 114 Uuq	unnilpentium 115 Uup	unnilhexium 116 Uuh	unnilseptium 117 Uus	ununoctium 118 Uuo

* Lanthanoids

** Actinoids

Chemical series of the periodic table

Alkali metals	Alkaline earth metals	Lanthanides	Actinides	Transition metals
Poor metals	Metalloids	Nonmetals	Halogens	Noble gases

6.3.1 Features of Long Form of Periodic Table

The long form of periodic table helps us to understand the reason why certain elements resemble one another and why they differ from other elements in their properties. The arrangement of elements in this table is also in keeping with their electronic structures (configuration). In table 6.5, you must have noticed that it is divided into columns and rows. The columns represent the **groups** or family and the rows represent the **periods**.

- 1. Groups:** There are 18 vertical columns in the periodic table. Each vertical column is called a **group**. The groups have been numbered from 1 to 18 (in Arabic numerals).

All elements present in a group have similar electronic configurations and have same number of valence electrons. You can see in case of group 1 (alkali metals) and group 17 elements (halogens) that as one moves down a group, more and more shells are added as shown in Table 6.6.

Table 6.6

Group 1		Group 17	
Element	Electronic configuration	Element	Electronic configuration
Li	2,1	F	2,7
Na	2,8,1	Cl	2,8,7
K	2,8,8,1	Br	2,8,8,7
Rb	2,8,18,8,1	I	2,8,18,18,7

All elements of group 1 have only one valence electron. Li has electrons in two shells, Na in three, K in four and Rb has electrons in five shells. Similarly all the elements of group 17 have seven valence electrons however the number of shells is increasing from two in fluorine to five in iodine.

- 2. Periods:** There are *seven* horizontal rows in the periodic table. Each row is called a **period**. The elements in a period have consecutive atomic numbers. The periods have been numbered from 1 to 7 (in Arabic numerals).

In each period a new shell starts filling up. The period number is also the number of the shell which starts filling up as we move from left to right across that particular period. For example, in elements of 3rd period ($N = 3$), the third shell (M shell) starts filling up as we move from left to right*. The first element of this period, sodium (Na 2,8,1) has only one electron in its valence shell (third shell) while the last element of this period, argon (Ar 2,8,8) has eight electrons in its valence shell. The gradual filling of the third shell can be seen below.

Element Period →	Na	Mg	Al	Si	P	S	Cl	Ar
Electronic configuration	2,8,1	2,8,2	2,8,3	2,8,4	2,8,5	2,8,6	2,8,7	2,8,8

* However, it should be noted here that more and more electrons are added to valence shell only in case of normal elements. In transition elements, the electrons are added to incomplete inner shells.



Notes



- (a) The first period is the *shortest period* of all. It contains only two elements; H and He.
- (b) The second and third periods are called *short periods* containing 8 elements each.
- (c) The fourth and fifth periods are *long periods* containing 18 elements each.
- (d) The sixth and seventh periods are *very long periods* containing 32 elements each.

6.3.2 Types of Elements

1. **Main Group Elements:** The elements present in groups 1 and 2 on left side and groups 13 to 17 on the right side of the periodic table are called *representative* or *main group elements*. Their outermost shells are incomplete, which means their outermost shell has less than eight electrons.
2. **Noble Gases:** Group 18 on the extreme right side of the periodic table contains *noble gases*. Their outermost shells contain 8 electrons except He which contains only 2 electrons.

Their main characteristics are :

- (a) They have 8 electrons in their outermost shell (except **He** which has 2 electrons).
 - (b) Their combining capacity or valency is zero.
 - (c) They do not react and so are almost inert.
 - (d) All the members are gases.
3. **Transition Elements:** The middle block of periodic table (groups 3 to 12) contains *transition elements*. Their two outermost shells are incomplete.

Since these elements represent a transition (change) from the most electropositive element to the most electronegative element, they are named as *transition elements*.

Their important characteristics are as follows:

- (a) All these elements are metals and have high melting and boiling points.
 - (b) They are good conductors of heat and electricity.
 - (c) Some of these elements get attracted towards magnet.
 - (d) Most of these elements are used as catalyst.
 - (e) They exhibit variable valencies.
4. **Inner Transition Elements:** These elements, also called *rare-earth elements*, are shown separately below the main periodic table. These are *two series of*

14 elements each. The first series called **lanthanoids** consists of elements 58 to 71 (Ce to Lu). They all are placed along with the element 57, *lanthanum* (La) in the same position (group 3, period 6) because of very close resemblance between them. It is only for the sake of convenience that they are shown separately below the main periodic table.

The second series of 14 rare-earth elements is called **actinoids**. It consists of elements 90 to 103 (Th to Lr) and they are all placed along with the element 89, *actinium* (Ac) in the same position (group 3, period 7) but for convenience they are shown below the main periodic table.

In all rare-earths (lanthanoids and actinoids), *three outermost* shells are incomplete. They are therefore called *inner transition elements*.

It is interesting to note that the element lanthanum *is not* a lanthanoid and the element actinium *is not* an actinoid.

5. **Metals:** *Metals* are present in the left hand portion of the periodic table. The strong metallic elements; *alkali metals* (Li, Na, K, Rb, Cs, Fr) and *alkaline earth metals* (Be, Mg, Ca, Sr, Ba, Ra) occupy groups 1 and 2 respectively.
6. **Non-metals:** *Non-metals* occupy the right hand portion of the periodic table. Strong non-metallic elements *i.e.*, *halogens* (F, Cl, Br, I, At) and *chalcogens* (O, S, Se, Te, Po) occupy groups 17 and 16 respectively.
7. **Metalloids:** *Metalloids* are the elements that show mixed properties of both metals and non-metals. They are present along the diagonal line starting from group 13 (Boron) and going down to group 16 (Polonium).



ACTIVITY 6.1

Rearrange the alphabets to get the correct name of the element in the space provided and mention its position in the modern periodic table

- (a) RGANO is a noble gas which is placed in group and third period of the modern periodic table.
- (b) HULIMIT is an alkali metal which is placed in group 1 and period of the modern periodic table.
- (c) MILCUAC is an alkaline earth metal which is placed in group and fourth period of the modern periodic table.
- (d) POHSROSUHP is a metalloid which is placed in group 15 and period of the modern periodic table.



Notes



Notes

6.3.3 Merits of the Modern Periodic Table

The following points overcame the defects of Mendeleev's periodic table, that is why, it was accepted by scientists across the world

1. **Position of isotopes:** All isotopes of an element have the same atomic number and therefore, occupy the same position in the modern periodic table.
2. **Anomalous pairs:** The anomaly regarding all these pairs disappears when *atomic number* is taken as the basis for classification. For example, cobalt (at. no. 27) would naturally come before nickel (at. no. 28) even though its atomic mass is little more than that of nickel.
3. **Electronic configuration:** This classification is according to the electronic configuration of elements, *i.e.*, the elements having a certain pattern of electronic configuration are placed in the same group of the periodic table. It relates the properties of elements to their electronic configurations. This point will be further elaborated in the next section.
4. **Separation of metals and non-metals:** The position of metals, non-metals and metalloids are clearly established in the modern periodic table.
5. **Position of transition metals:** It makes the position of the transition elements quite clear.
6. **Properties of elements:** It reflects the differences, the trends and the variations in the properties of the elements in the periodic table.
7. This table is simple, systematic and easy way of remembering the properties of different metals.



INTEXT QUESTIONS 6.2

1. Give any two defects of Mendeleev's periodic table which has been removed in modern periodic table. How were they removed?
2. Metalloids are present along the diagonal line starting from group 13 and going down to group 16. Do they justify their position in the modern periodic table?

6.4 PERIODIC TRENDS IN PROPERTIES

You have learnt about the main features of the long form of the periodic table in the previous section, and you know that it consists of groups and periods. Let us recall their two important features:

1. In a given group, the number of filled shells increases. The number of valence electrons is the same in all the elements of a given group. However, these valence

electrons but they are present in higher shells which are farther away from the nucleus. In view of this, decreases the force of attraction between the outermost shell and the nucleus as we move downwards in a group.

- In a given period, the nuclear charge and the number of valence electrons in a particular shell increase from left to right. This increases the force of attraction between the valence electron and nucleus as we move across a period from left to right.

The above given changes affect various properties which show gradual variations in groups and periods, and they repeat themselves after certain intervals of atomic number. They are called *periodic properties*. Now you are going to learn the variations of two of such properties in the periodic table.

A. Atomic Size

Atomic size is the distance between the centre of nucleus and the outermost shell of an isolated atom. It is also known as *atomic radius*. It is measured in picometre, pm ($1 \text{ pm} = 10^{-12} \text{ m}$). Atomic size is a very important property of atoms because it is related to many other properties.

Variation of atomic size in periodic table.

The size of atoms *decreases from left to right in a period* but *increases from top to bottom in a group*. For example, the atomic radii of the elements of the second period and of group 1 are given below in the tables 6.7 and 6.8 respectively.

Table 6.7 : Atomic radii of period 2 elements

Atomic Number	3	4	5	6	7	8	9
Elements : (in second period)	Li	Be	B	C	N	O	F
Atom radius/pm :	134	90	82	77	75	73	72
Atomic Size	○	○	○	○	○	○	○

In a period the atomic number and therefore the positive charge on the nucleus increases gradually. As a result, the electrons are attracted more strongly and they come closer to the nucleus. This decreases the atomic size in a period from left to right.

In a group as one goes down, a new shell is added to the atom which is farther away from the nucleus. Hence electrons move away from the nucleus. This increases the atomic size in a group from top to bottom.



Notes



Notes

Table 6.8 : Atomic radii of group 1 elements

Atomic Number	Elements (in groups I)	Atom radius/pm	Atomic Size
3	Li	134	
11	Na	154	
19	K	196	
37	Rb	211	
55	Cs	225	

B. Metallic and Non-metallic Character

The tendency of an element to lose electrons to form cations is called *electropositive or metallic character* of an element. Alkali metals are most electropositive. The tendency of an element to accept electrons to form anions is called *electronegative or non-metallic character* of an element.

(a) Variation of Metallic Character in a Group

Metallic character increases from top to bottom in a group as tendency to lose electrons increases. This increases the electropositive character and metallic nature. The variation can best be seen in group 14 as shown below.

Table 6.9: Metallic character of groups 14 elements

Element	Nature
C	Non-metal
Si	Metalloid
Ge	Metalloid
Sn	Metal
Pb	Metal

(b) Variation of Metallic Character in a Period

Metallic character decreases in a period from left to right. It is because the ionization energy increases in a period. This decreases the electropositive character and metallic nature. The variation of metallic character in the elements of 3rd period is shown below.

Table 6.10 : Metallic character of 3rd period elements

Element	Na	Mg	Al	Si	P	S	Cl
Nature	Metal	Metal	Metal	Metalloid	Non-Metal	Non-Metal	Non-Metal



Notes

In this section, you have learnt about variation of some properties in periodic table. Some important trends in periodic table may be summarized in a general way as given below :

Table 6.11 : Variation of various periodic properties in periods and groups

Property	In a Period (From left to right)	In a Group (From top to Bottom)
Atomic number	increases	increases
Atomic size	decreases	increases
Metallic character	decreases	increases
Non-metallic character	increases	decreases



INTEXT QUESTIONS 6.3

- Fill in the blanks with appropriate words
 - The force of attraction between nucleus and valence electrons in a period from left to right.
 - Atomic radii of elements in a period from left to right.
 - Atomic radii of elements in a group from top to bottom.
 - Metallic character of elements from top to bottom in a group.
- In the following crossword puzzle, elements are present horizontally, vertically downwards and diagonally downwards. Let us find out how many elements you are able to get within 5 minutes.

MODULE - 2

Matter in our Surroundings



Notes

Periodic Classification of Elements

Z	N	H	Y	D	R	O	G	E	N
M	B	I	C	A	R	B	O	N	O
A	D	E	T	B	A	R	I	U	M
G	X	Y	H	R	M	U	S	A	S
N	A	D	E	O	O	A	O	O	I
E	I	U	J	P	X	G	I	S	L
S	O	D	I	U	M	Y	E	L	I
I	D	M	U	X	A	I	G	N	C
U	I	O	M	O	G	E	Y	E	O
M	N	D	P	S	B	O	R	O	N
A	E	C	H	L	O	R	I	N	E

Please check in the intext answers to find if you missed out any.

3. Let us find how many riddles you can solve.
- I am the only noble gas whose outermost shell has 2 electrons. Who am I?
 - I am placed in group 16 of the modern periodic table and essential for your respiration. Who am I?
 - I combine with chlorine to form your table salt. Who am I?
- (Hint: Answers are present in the grid]



WHAT YOU HAVE LEARNT

- The first classification of elements was as metals and non-metals.
- After the discovery of atomic mass (old term, atomic weight) it was thought to be the fundamental property of elements and attempts were made to correlate it to their other properties.
- John Dobereiner grouped elements into triads. The atomic mass and properties of the middle element were mean of the other two. He could group only a few elements into triads. For example (i) Li, Na and K (ii) Ca, Sr and Ba (iii) Cl, Br and I.



Notes

- Newlands tried to see the periodicity of properties and stated his law of octaves as “When elements are arranged in the increasing order of their atomic weights every eighth element has properties similar to the first”. He could arrange elements up to calcium only out of more than sixty elements then known.
- Mendeleev observed the correlation between atomic weight and other properties and stated his periodic law as, “The chemical and physical properties of elements are a periodic function of their atomic weights”.
- Mendeleev gave the first periodic table which is named after him which included all the known elements. It consists of seven horizontal rows called **periods** and numbered them from 1 to 7. It has eight vertical columns called **groups** and numbered them from I to VIII.
- Main achievements of Mendeleev’s periodic table were (i) inclusion of all the known elements and (ii) prediction of new elements.
- Main defects of Mendeleev’s periodic table were (i) position of isotopes, (ii) anomalous pairs of elements like Ar and K and (iii) grouping of dissimilar elements and separation of similar elements.
- Moseley discovered that atomic number and not atomic mass is the fundamental property of elements. In the light of this the periodic law was modified to “The chemical and physical properties of elements are periodic functions of their atomic numbers”. This is the Modern Periodic Law.
- Modern Periodic Table is based upon atomic number. Its long form has been accepted by IUPAC. It has seven periods (1 to 7) and 18 groups (1 to 18). It is free of main defects of Mendeleev’s periodic table. Elements belonging to same group have same number of valence electrons and thus show same valency and similar chemical properties.
- Arrangement of elements in the periodic table shows periodicity. Atomic radii and metallic character increase in a group from top to bottom and in a period decrease from left to right.

**TERMINAL EXERCISE****A. Objective questions****I. Mark the correct choice:**

1. Which one of the following was the earliest attempt of classification of elements?
 - (a) Classification of elements into metals and non-metals
 - (b) Newlands’ Law of Octaves



Notes

- (c) Dobereiner's Triads
(d) Mendeleef's Periodic Table
2. The 'law of octaves' was given by
(a) Mendeleev (b) Newlands
(c) Lothar Meyer (d) Dobereiner
3. According to the periodic law given by Mendeleev, the properties of an element are a periodic function of its
(i) atomic volume (ii) atomic size
(iii) atomic number (iv) atomic mass
4. The particle which is universally present in the nuclei of all elements is
(a) neutron (b) proton
(c) electron (d) α -particle
5. Potassium is more metallic than sodium because
(a) both have 1 electron in their outermost shell.
(b) both are highly electropositive.
(c) sodium is larger in size than potassium.
(d) potassium is larger in size than sodium.
7. Which one of the following elements in its chloride does not show the valence equal to its valence electrons?
(a) NaCl (b) $MgCl_2$
(c) $AlCl_3$ (d) PCl_3
8. Which one of the following elements has the least tendency to form cation?
(a) Na (b) Ca
(c) B (d) Al
9. Which one of the following does not belong to the family of the alkali metals?
(a) Li (b) Na
(c) Be (d) K
10. The number of elements in the 5th period of the periodic table is
(a) 2 (b) 8
(c) 32 (d) 18
11. The elements with atomic number 9 resembles with the element having atomic number
(a) 35 (b) 27
(c) 17 (d) 8

12. In which period of the periodic table, an element with atomic number 20 is placed?

- (a) 4 (b) 3
(c) 2 (d) 1



Notes

II. Mark the following statements True (T) or False (F) :

1. The properties of the middle element in a Dobereiner's triads are intermediate between those of the other two.
2. The vertical columns in the periodic table are called periods.
3. Mendeleev depended only on the atomic mass of elements for his classification.
4. All elements present in a group are chemically similar.
5. The modern periodic law is based upon atomic mass.
6. The importance of atomic number as the fundamental property was realised by Henry Mosely.
7. There are 18 groups in the modern periodic table.
8. Non-metals are present in the middle portion of the periodic table.
9. Each period in modern periodic classification begins with filling of electrons in a new shell.

III. Fill in the blanks:

1. According to the modern periodic law, the properties of elements are periodic function of their
2. The number is same as the number of shell which in gradually filled up in the elements of this period.
3. In normal elements of a particular period the electrons are gradually filled in shell.
4. All elements of a particular group have electronic configurations.
5. In the modern periodic table, groups are numbered from to
6. The second and third periods of the periodic table are called periods.
7. The main group elements are present in group 1 and 2 on the left side and to on the right side of the periodic table.



8. All the group eighteen elements (except the first one) contain valence electrons.
9. All transition elements are metals with melting and boiling points.
10. The group of 14 rare-earth elements belonging to the group 3 and 7th period are called
11. All elements present in a given have the same valency.
12. Atomic size in a period from left to right.
13. Magnesium is metallic than calcium.
14. Carbon belongs to group of the Periodic table.
15. All the elements of group 15 have valence electrons.

B. Subjective Questions

I. Very short Answer Questions (Answer in one word or one sentence).

1. What was the earliest classification of elements?
2. State Newlands' law of octaves.
3. Which classification of elements failed after the discovery of noble gases?
4. State Mendeleev's Periodic Law.
5. How were the groups numbered in the Mendeleev's periodic table?
6. Name the fundamental properties of element on which the modern periodic law is based.
7. How many groups are there in the modern periodic table?
8. How have groups been numbered in the modern periodic table?
9. What are normal elements?
10. What are the elements present in the middle portion of the modern periodic table called?
11. What is atomic size?
12. How does atomic size vary in a period and in a group?
13. Where would the element with largest atomic size be placed in any group?
14. Give the number of a group in which metallic, metalloid and non-metallic, all three types of elements, are present.

II. Short Answer Questions (Answer in 30-40 words).

1. State Dobereiner's law of triads.
2. Show that chlorine, bromine and iodine (atomic masses 35.5, 80 and 127 respectively) constitute a triad.



Notes

3. What were the reasons for the failure of Newlands' law of octaves ?
4. Describe Mendeleev's periodic table briefly in terms of rows and columns and their raw being.
5. Give any two achievements of the Mendeleev's Periodic classification.
6. What were the defects in Mendeleev's periodic classification.
7. State modern periodic law.
8. Briefly describe the modern periodic table in term of groups and period.
9. Give names of four classes into which the elements have been classified and mention to which groups of the modern period table they belong.
10. List the merits of the long form of the modern periodic table and explain any two of them.
11. How are the electronic configurations of all the elements belonging to a particular group related? Explain with the help of group 17 elements.
12. How does the electronic configuration of elements belonging to a particular period vary? Explain with the example of second period elements.
13. Define atomic radius.
14. How and why does metallic character vary in a group from top to bottom?

III. Long Answer Questions (Answer in 60–70 words).

1. State Mendeleev's Periodic Law and describe the periodic table constructed on this basis.
2. What are the merits and demerits of the Mendeleev's Periodic classification?
3. Describe the modern periodic table in terms of groups and periods.
4. What are the following types of elements and where are they located in the periodic table?
 - (a) Main group elements
 - (b) Noble gases
 - (c) Transition elements
 - (d) Inner transition elements.
5. Discuss the merits of the modern periodic table.
6. What is the relationship between the electronic configuration and the modern periodic table?
8. Explain the variation of atomic size in a group and in a period.
9. How is metallic character related to ionization energy ? Explain the variation of metallic character in the periodic table.



Notes



ANSWERS TO INTEXT QUESTIONS

6.1

- Atomic mass of B = $\frac{20 + 40}{2} = 30$
- Atomic mass
- Group
- These were the positions of elements which were yet to be discovered.
- Any three of the following: (i) position of hydrogen (ii) position of isotopes (iii) anomalous pairs of elements (iv) grouping of chemically dissimilar element (v) separation of chemically similar element (vi) no explanation for electronic configuration

6.2

- Anomalous pairs when elements are arranged in the order of their increasing atomic numbers, these anomalies are automatically removed, since the atomic number of the first element is less than that of the second although their atomic masses show reverse trends.
- Position of isotopes. Since all the isotopes of an element have the same atomic number, they all will occupy the same position in the periodic table.

6.3

- | | |
|---------------|---------------|
| (a) increases | (b) decreases |
| (c) increases | (d) increases |
- Hydrogen, Carbon, Barium, Sodium, Boron, Chlorine (horizontally)
Magnesium, Iodine, Helium, Neon, Silicon, (vertically downwards)
Nitrogen, Oxygen (diagonally downwards)
- | | | |
|------------|-------------|--------------|
| (i) Helium | (ii) Oxygen | (iii) Sodium |
|------------|-------------|--------------|

Activity 6.1

- | | | | |
|-----------|-------------|-------------|-----------------|
| (a) Argon | (b) Lithium | (c) Calcium | (d) Phosphorous |
|-----------|-------------|-------------|-----------------|



7

CHEMICAL BONDING

In lesson 5, you have read about the electronic configuration of atoms of various elements and variation in the periodic properties of elements. We see various substances around us which are either elements or compounds. You also know that atoms of the same or different elements may combine. When atoms of the same elements combine, we get molecules of the elements. But we get compounds when atoms of different elements combine. Have you ever thought why atoms combine at all?

In this lesson, we will find an answer to this question. We will first explain what a chemical bond is and then discuss various types of chemical bonds which join the atoms together to give various types of substances. The discussion would also highlight how these bonds are formed.

The properties of substances depend on the nature of bonds present between their atoms. In this lesson you will learn that sodium chloride, the common salt and washing soda dissolve in water whereas methane gas or naphthalene do not. This is because the type of bonds present between them are different. In addition to the difference in solubility, these two types of compounds differ in other properties as well about which you will study in this lesson.



OBJECTIVES

After completing this lesson you will be able to :

- recognize the stability of noble gas configuration and tendency of other elements to attain this configuration through formation of chemical bonds;
- explain the attainment of stable noble gas electronic configuration through transfer of electrons resulting in the formation of ionic bonds;



Notes

- describe and justify some of the common properties of ionic compounds;
- explain the alternate mode of attainment of stable noble gas configuration through sharing of electrons resulting in the formation of covalent bonds;
- describe the formation of single, double and triple bonds and depict these with the help of Lewis-dot method;
- describe and justify some of the common properties of covalent substances.

7.1 WHY DO ATOMS COMBINE?

The answer to this question is hidden in the electronic configurations of the noble gases. It was found that noble gases namely helium, neon, argon, krypton, xenon and radon did not react with other elements to form compounds i.e. they were non-reactive. In the initial stages they were also called inert gases due to their non-reactive nature. Thus it was, thought that these noble gases lacked reactivity because of their specific electronic arrangements which were quite stable. When we write the electronic configurations of the noble gases (see table below), we find that except helium all of them have 8 electrons in their outermost shell.

Table 7.1 : Electronic configuration of Noble gases

Name	Symbol	Atomic Number	Electronic Configuration	No. of electrons in the outermost shell
Helium	He	2	2	2
Neon	Ne	10	2,8	8
Argon	Ar	18	2,8,8	8
Krypton	Kr	36	2,8,18,8	8
Xenon	Xe	54	2,8,18,18,8	8
Radon	Ra	86	2,8,18,32,18,8	8

It was concluded that atoms having 8 electrons in their outermost shell are very stable and they did not form compounds. It was also observed that other atoms such as hydrogen, sodium, chlorine etc. which do not have 8 electrons in their outermost shell undergo chemical reactions. They can stabilize by combining with each other and attain the above configurations of noble gases i.e. 8 electrons (or 2 electrons in case of helium) in their outermost shells. Thus, atoms tend to attain a configuration in which they have 8 electrons in their outermost shells. This is the basic cause of chemical bonding. This attainment of eight electrons for stable structure is called the **octet rule**. The octet rule explains the chemical bonding in many compounds.

Atoms are held together in compounds by the forces of attraction which result in formation of **chemical bonds**. The formation of chemical bonds results in the lowering

of energy which is less than the energy the individual atoms. The resulting compound is lower in energy as compared to sum of energies of the reacting atom/molecule and hence is more stable. Thus stability of the compound formed is an important factor in the formation of chemical bonds. In rest of the lesson you will study about the nature of bonds present in various substances. We would explain *ionic bonding and covalent bonding in this lesson*. Before you start learning about ionic bonding in the next section you can answer the following questions to check your understanding.



Notes



INTEXT QUESTIONS 7.1

1. State octet rule
2. Why noble gases are non-reactive?
3. In the table given below three elements and their atomic numbers are given. Which of them are stable and will not form compound?

Element	At. No.	Stable/Unstable
A	10	
B	36	
C	37	

7.2 IONIC BONDING

The chemical bond formed by transfer of electron from a metal to a non-metal is known as *ionic* or *electrovalent bond*.

For example, when sodium metal and chlorine gas are brought into contact, they react violently and we obtain sodium chloride. This reaction is shown below:

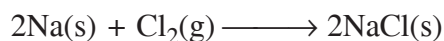

The bonding in sodium chloride can be understood as follows:

Sodium (Na) has the atomic number 11 and we can write its electronics configuration as 2,8,1 i.e. it has one electron in its outermost (M) shell. If it loses this electron, it is left with 10 electrons and becomes positively charged. Such a positively charged ion is called a cation. The cation in this case is called sodium cation, Na^+ . This is shown below in Fig. 7.1.



Notes

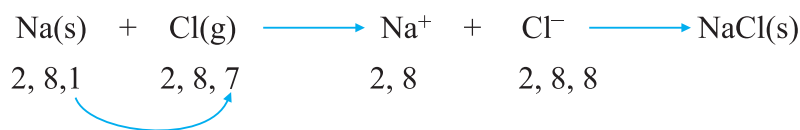

Fig. 7.1 Formation of NaCl

Note that the sodium cation has 11 protons but 10 electrons only. It has 8 electrons in the outermost (L) shell. Thus, sodium atom has attained the noble gas configuration by losing an electron present in its outermost shell. Loss of electron results into formation of an ion and this process is called *ionization*. Thus, according to octet rule, sodium atom can acquire stability by changing to sodium ion (Na^+).

The ionization of sodium atom to give sodium ion requires an energy of 496 kJ mol^{-1} .

Now, chlorine atom having the atomic number 17, has the electronic configuration 2,8,7. It completes its octet by gaining one electron from sodium atom (at. no. 11) with electronic configuration 2, 8, 1.

Both sodium ion (Na^+) and chloride ion (Cl^-) combine together by ionic bond and become solid sodium chloride (NaCl).

Note that in the above process, the chlorine atom has gained an additional electron hence it has become a negatively charged ion (Cl^-). Such, a negatively charged ion is called an **anion**. Chloride ion has 8 electrons in its outermost shell and it therefore, has a stable electronic configuration according to the octet rule. The formation of chloride ion from the chlorine atom releases 349 kJ mol^{-1} of energy.

Since the **cation** (Na^+) and the **anion** (Cl^-) formed above are electrically charged species, they are held together by Coulombic force or electrostatic force of attraction. This **electrostatic force of attraction which holds the cation and anion together is known as electrovalent bond or ionic bond**. This is represented as follows:

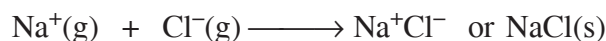

Note that only outermost electrons are shown above. Such structures are also called **Lewis Structures**.

If we compare the energy required for the formation of sodium ion and that released in the formation of chloride ion, we note that there is a net difference of 147 kJ mol^{-1} of energy. If only these two steps are involved, the formation of sodium chloride is not favourable energetically. But sodium chloride exists as a crystalline solid. This is because the energy is released when the sodium ions and the chloride ions come together to form the crystalline structure. The energy so released compensates for the above deficiency of energy.

You can see that *each sodium ion is surrounded by six chloride ions and each chloride ion is surrounded by six sodium ions* in its solid state structure. The force of attraction between sodium and chloride ions is uniformly felt in all directions. Thus, no particular sodium ion is bonded to a particular chloride ion. Hence, there is no species such as NaCl. Here NaCl is empirical formula and shows that there is one Na⁺ for every Cl⁻ Fig. 7.2.

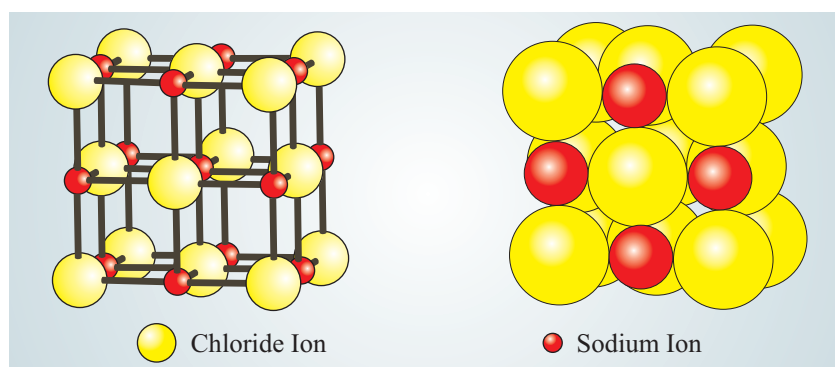

Fig. 7.2 Structure of sodium chloride

Similarly, we can explain the formation of cations resulting from lithium and potassium atoms and the formation of anions resulting from fluorine, oxygen and sulphur atoms.

Let us now study the formation of another ionic compound namely magnesium chloride. Mg has atomic number 12. Thus, it has 12 protons. The number of electrons present in it is also 12. Hence the electronic configuration of Mg atom is 2, 8, 2.

Let us consider the formation of magnesium ion from a magnesium atom. We see that it has 2 electrons in its outermost shell. If it loses these two electrons, then we can achieve the stable configuration of 2, 8 (that of noble gas neon). This can be represented in Fig. 7.3.

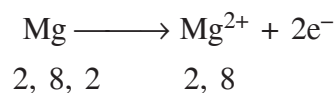
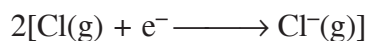

Fig. 7.3 Formation of magnesium ion

You can see that the resulting magnesium ion has only 10 electrons and hence it has 2+ charge. It is a dipositive ion and can be represented as Mg²⁺ ion.

The two electrons lost by the magnesium are gained -one each by two chlorine atoms to give two chloride ions.



Thus, one magnesium ion and two chloride ion join together to give magnesium chloride, MgCl₂. Hence we can write as in Fig. 7.4.



Notes



Notes

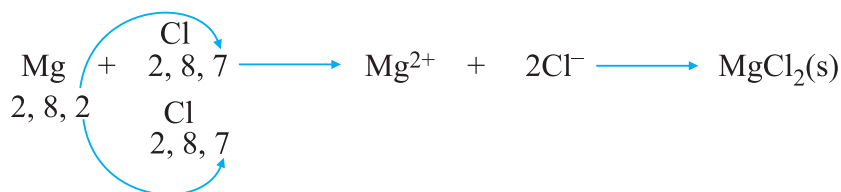

Fig. 7.4 Formation of magnesium chloride

Let us now see what would happen if instead of chloride ion, the magnesium ion combines with another anion say oxide anion. The oxygen atom having atomic number eight has 8 electrons. Its electronic configuration is 2,6. It can attain a stable electronic arrangement (2,8) of the noble gas neon if it gains two more electrons. The two electrons, which are lost by the magnesium atom, are gained by the oxygen atom. On gaining these two electrons, the oxygen atom gets converted into the oxide anion. This is shown below in Fig. 7.5.

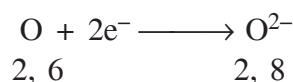

Fig. 7.5 Formation of oxide ion

The oxide has 2 more electrons as compared to the oxygen atom. Hence, it has 2 negative charges on it. Therefore, it can be represented as O^{2-} ion

The magnesium ion (Mg^{2+}) and the oxide ion (O^{2-}) are held together by electrostatic force of attraction. This leads to the formation of magnesium oxide Fig. 7.6.

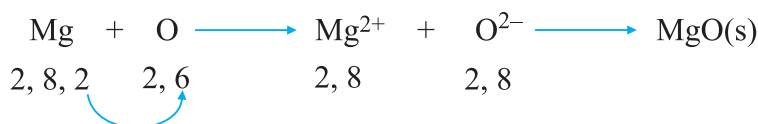

Fig. 7.6 Formation of magnesium oxide

Thus, magnesium oxide is an ionic compound in which a dipositive cation (Mg^{2+}) and a dinegative anion (O^{2-}) are held together by electrostatic force.

Similar to the case of sodium chloride, the formation of magnesium oxide is also accompanied by lowering of energy which leads to the stability of magnesium oxide as compared to individual magnesium and oxygen atoms.

Similarly, the ionic bonding present in many other ionic compounds can be explained. The ionic compounds show many characteristic properties which are discussed below.

7.2.1 Properties of Ionic Compounds

Since the ionic compounds contain ions (cations and anions) which are held together by the strong electrostatic forces of attraction, they show the following general characteristic properties:

(a) Physical State

Ionic compounds are crystalline solids. In the crystal, the ions are arranged in a regular fashion. The ionic compounds are hard and brittle in nature.

(b) Melting and boiling points

Ionic compounds have high melting and boiling points. The melting point of sodium chloride is 1074 K (801°C) and its boiling point is 1686K (1413°C). The melting and boiling points of ionic compounds are high because of the strong electrostatic forces of attraction present between the ions. Thus, it requires a lot of thermal energy to overcome these forces of attraction. The thermal energy given to the ionic compounds is used to overcome the interionic attractions present between the cations and anions in an ionic crystal. Remember that the crystal has a three dimensional regular arrangement of cations and anions which is called **crystal lattice**. On heating, the breaking of this crystal lattice leads to the molten state of the ionic compound in which the cations and anions are free to move.

(c) Electrical Conductivity

Ionic compounds conduct electricity in their molten state and in aqueous solutions. Since ions are free to move in the molten state, they can carry current from one electrode to another in a cell. Thus ions can conduct electricity in molten state. However, in solid state, such a movement of ions is not possible as they occupy fixed positions in the crystal lattice. Hence in solid state, ionic compounds do not conduct electricity.

In aqueous solution, water is used as a solvent to dissolve ionic compounds. It weakens the electrostatic forces of attraction present among the ions. When these forces are weakened, the ions become free to move, hence they can conduct electricity.



ACTIVITY 7.1

Prepare a solution of NaCl by dissolving 1 tablespoon of it in 100 mL water. Take this solution in a 200 mL beaker and introduce two graphite electrode (obtained from used dry cell battery), Now connect the electrode with a 3 V dry cell and a bulb in a circuit as shown in Fig. 7.7. Initially take plain water in a beaker (200 mL) and see the glow of bulb. Now replace the plain water by the solution of NaCl, what difference in glow of the bulb is observed? Interpret the result on the basis of ionic bond you have just studied.



Notes



Notes

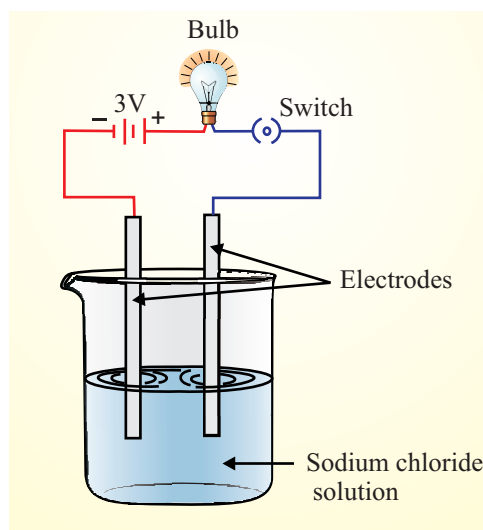

Fig. 7.7 Aqueous solution of sodium chloride conducts electricity

(d) Solubility

Ionic compounds are generally soluble in water but are insoluble in organic solvents such as ether, alcohol, carbon tetrachloride etc. However, a few ionic compounds are insoluble in water due to strong electrostatic force between cation and anion. For example barium sulphate, silver chloride and calcium fluoride.



ACTIVITY 7.2

Take nearly 10 g of NaCl, and two boiling tubes. In boiling tube (1) take 10 mL of water and add nearly 4 g of powdered NaCl. In test tube (2) take nearly 10 mL of ethyl alcohol and add nearly 4 g of powdered NaCl. Shake both the test tube vigorously and see change in the amount of NaCl added in each case Fig. 7.8. Write your observation

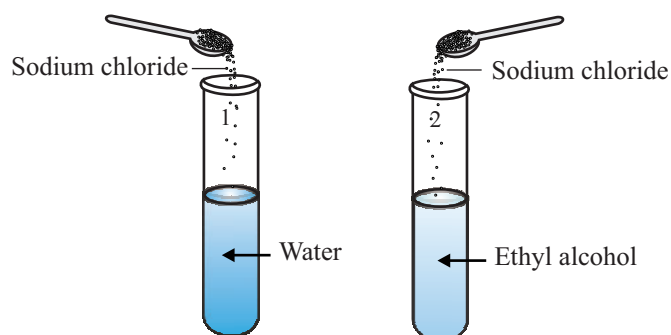

Fig. 7.8 Showing solubility of NaCl in water and ethyl alcohol

Before proceeding to the next section in which covalent bonding is discussed, why don't you answer the following questions to test your understanding about the ionic bonding?



INTEXT QUESTIONS 7.2

1. Name the two types of ions present in NaCl.
2. How many shells are present in Na^+ ion?
3. What is the number of electrons present in Cl^- ion?
4. Name the type of force of attraction present in ionic compounds.
5. In sodium chloride lattice, how many Cl^- ions surround each Na^+ ion?
6. Show the formation of Na_2O , CaCl_2 and MgO .
7. Why NaCl is bad conductor of electricity in solid state?

7.3 COVALENT BONDING

In this section, we will study about another kind of bonding called *covalent bonding*. Covalent bonding is helpful in understanding the formation of molecules. In lesson 2, you studied that molecules having similar atoms such as H_2 , Cl_2 , O_2 , N_2 etc. are molecules of elements whereas those containing different atom like HCl , NH_3 , CH_4 , CO_2 etc. are molecule of compounds. Let us now see how are these molecules formed?

Let us consider the formation of hydrogen molecule (H_2). The hydrogen atom has one electron. It can attain the electronic configuration of the noble gas helium by sharing one electron of another hydrogen atom. When the two hydrogen atoms come closer, there is an attraction between the electrons of one atom and the proton of another and there are repulsions between the electrons as well as the protons of the two hydrogen atoms. In the beginning, when the two hydrogen atoms approach each other, the potential energy of the system decreases due to the force of attraction. (Fig. 7.9) The value of potential energy reaches a minimum at some particular distance

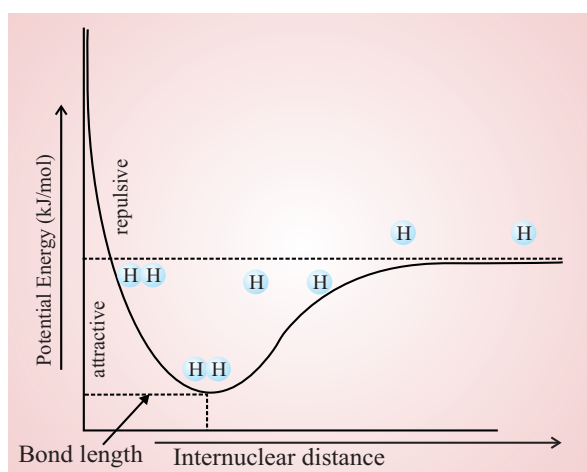

Fig. 7.9 Potential energy diagram for formation of a hydrogen molecule



Notes



Notes

between the two atoms. If the distance between the two atoms further decreases, the potential energy increases because of the forces of repulsion. **The covalent bond forms when the forces of attraction and repulsion balance each other and the potential energy is minimum.** It is this lowering of energy which leads to the formation of the covalent bond.

Formation of covalent bond in H₂ can be shown as

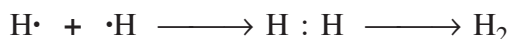

We will next consider the formation of chlorine molecule (Cl₂). A molecule of chlorine contains two atoms of chlorine. Now how are these two chlorine atoms held together in a chlorine molecule?

You know that the electronic configuration of Cl atom is 2,8,7. Each chlorine atom needs one more electron to complete its octet. If the two chlorine atoms share one of their electrons as shown below, then both of them can attain the stable noble gas configuration of argon.

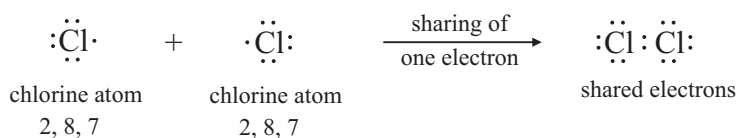

Note that the sharing pair of electrons is shown to be present between the two chlorine atoms. Each chlorine atom thus acquires 8 electrons. The shared pair of electrons keeps the two chlorine atoms bonded together. *Such a bond, which is formed by sharing of electrons between the atoms is called a **covalent bond**.* Thus, we can say that a covalent bond is present between two chlorine atoms. This bond is represented by drawing a line between the two chlorine atoms as follows:



Sometimes the electrons shown above on the chlorine atoms are omitted and the chlorine-chlorine bond is shown as follows:

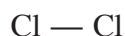

Similarly, we can understand the formation of oxygen molecule (O₂) from the oxygen atoms. The oxygen atom has atomic number 8. It has 8 protons and also 8 electrons. The electronic configuration of oxygen atoms is 2,6. Now each oxygen atom needs two electrons to complete its octet. The two oxygen atoms share two electrons and complete their octet as is shown below:

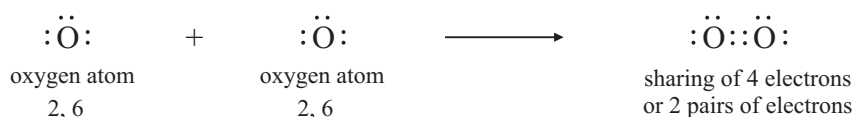

The 4 electrons (or 2 pairs of electrons) which are shared between two atoms of oxygen are present between them. Hence these two pairs of shared electrons can be represented by two bonds between the oxygen atoms. Thus, an oxygen molecule can be represented as follows:

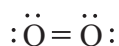

The two oxygen atoms are said to be bonded together by two covalent bonds. Such a bond consisting of two covalent bonds is also known as a **double bond**.

Let us next take the example of nitrogen molecule (N_2) and understand how the two nitrogen atoms are bonded together. The atomic number of nitrogen is 7. Thus it has 7 protons and 7 electrons present in its atom. The electronic configuration can be written as 2,5. To have 8 electrons in the outermost shell, each nitrogen atom requires 3 more electrons. Thus, a sharing of 3 electrons each between the two nitrogen atoms is required. This is shown below:

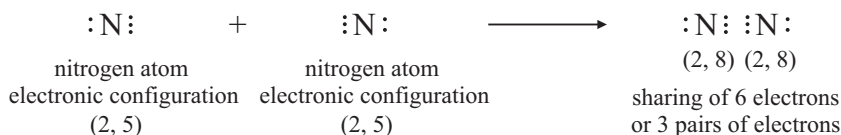

Each nitrogen atom provides 3 electrons for sharing. Thus, 6 electrons or 3 pairs of electrons are shared between the two nitrogen atoms. Hence, each nitrogen atom is able to complete its octet.

Since 6 electrons (or 3 pairs of electrons) are shared between the nitrogen atoms, we say that three covalent bonds are formed between them. These three bonds are represented by drawing three lines between the two nitrogen atoms as shown below:



Such a bond which consists of three covalent bonds is known as a **triple bond**. So far, we were discussing covalent bonds formation between atoms of the same elements. But covalent bonds can be formed by sharing of electrons between atoms of different elements also. Let us take the example of HCl to understand it.

A hydrogen atom has one electron in its outermost shell and a chlorine atom has seven electrons in its outermost shell. Each of these atoms has one electron less than the electronic configuration of the nearest noble gas. If they share one electron pair, then hydrogen can acquire two electrons in its outer most shell whereas chlorine will have eight electrons in its outermost shell. The formation of HCl molecule by sharing of one electron pair is shown below:

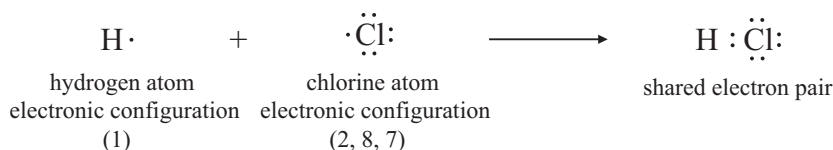

Notes



Notes

Similarly, we can explain bond formation in other covalent compounds.

After knowing the nature of bonding present in covalent compounds, let us now study what type of properties these covalent compounds have.

7.3.1 Properties of Covalent Substances

The covalent compounds consist of molecules which are electrically neutral in nature. The forces of attraction present between the molecules are less strong as compared to the forces present in ionic compounds. Therefore, the properties of the covalent compounds are different from those of the ionic compounds. The characteristic properties of covalent compounds are given below:

(a) Physical State

Because of the weak forces of attraction present between discrete molecules, called intermolecular forces, the covalent compounds exist as a gas or a liquid or a solid. For example O_2 , N_2 , CO_2 are gases; water and CCl_4 are liquids and iodine is a solid.

(b) Melting and Boiling Points

As the forces of attraction between the molecules are weak in nature, a small amount of energy is sufficient to overcome them. Hence, the melting points and boiling points of covalent compounds are lower than those of ionic compounds. For example, melting point of naphthalene which is a covalent compound is 353 K ($80^\circ C$). Similarly, the boiling point of carbon tetrachloride which is another covalent liquid compound is 350 K ($77^\circ C$).

(c) Electrical Conductivity

The covalent compounds contain neutral molecules and do not have charged species such as ions or electrons which can carry charge. Therefore, these compounds do not conduct electricity and are called poor conductors of electricity Fig. 7.10.

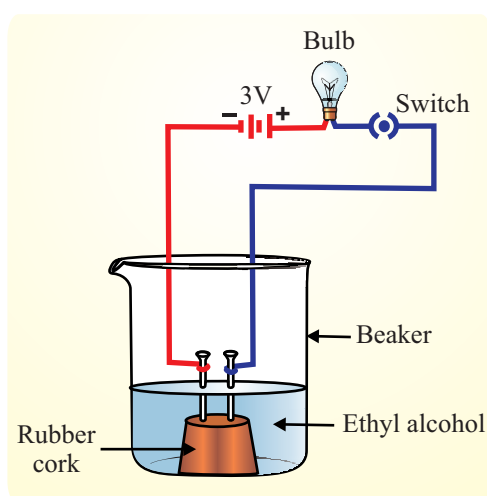

Fig. 7.10 Ethyl alcohol (a covalent compound) is non-conductor of electricity

(d) Solubility

Covalent compounds are generally not soluble in water but are soluble in organic solvents such as alcohol, chloroform, benzene, ether etc.

**ACTIVITY 7.3**

Take about 5 mL of ethyl alcohol in a test tube. Add few crystals of iodine. Shake the test tube well. What do you find? The colour of the ethyl alcohol becomes dark brown. What inference do you draw from this? Iodine is soluble in ethyl alcohol. Write your observation. Dissolve the same amount of iodine in the same volume of water. (Solution of iodine in ethyl alcohol is popularly known as tincture iodine and is used as an antiseptic solution.)

After understanding the nature of covalent bond and properties of covalent compounds. Why don't you answer the following questions to test your understanding about the covalent bonding.

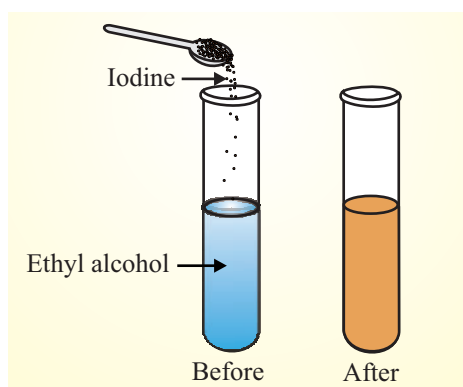

Fig. 7.11 Showing solubility of iodine in ethyl alcohol

**INTEXT QUESTIONS 7.3**

- How covalent bonds are formed?
- Show the formation of O_2 , HCl , Cl_2 and N_2 .
- How many covalent bond(s) is/are present in following compounds:
 - H_2O
 - HCl
 - O_2
 - N_2
- State loss or gain of electrons (giving their number) in the following changes :
 - $N \longrightarrow N^{3-}$
 - $Cl \longrightarrow Cl^-$
 - $Cu \longrightarrow Cu^{2+}$
 - $Cr \longrightarrow Cr^{3+}$
- Why ethyl alcohol is bad conductor of electricity in its aqueous solutions?



Notes



Notes



WHAT YOU HAVE LEARNT

- The basic cause of chemical bonding is to attain noble gas configuration either by transfer of electron from a metal to non-metal or by sharing of electrons between two non-metal atoms.
- Atoms of elements don't exist freely in the nature. In all, the atoms of all the elements except of noble gases, have less than eight electrons in the valence shell. Normally gases do not react with other elements in normal conditions as they have stable electronic configuration i.e. they have eight electrons in the valence shell or outer most shell.
- All the atoms have a tendency to acquire stable state or noble gas configuration. Therefore, they combine with atoms of other elements to acquire 08 electrons in the valence shell by giving, taking or sharing of electrons. This is the basic cause of Chemical bonding and is called **Octet Rule**.
- Atoms of elements in a molecule are held together by **Chemical Bonding**. The formation of chemical bonds result in the lowering of energy which is less than the energy of the individual atoms. The resulting compound is lower in energy and hence more stable.
- There are two types of chemical bonding : ionic bonding and covalent bonding.
- Ionic Bonding: The chemical bond formed by transfer of electrons from a metal to a non-metal is known as Ionic Bond or Electrovalent bond.
- The ionic bond formation takes place in three steps.
 - (i) Formation of Cations by metals with loss of electrons.
 - (ii) Formation of Anions by non-metal with gain of electrons.
 - (iii) Combination of Cations and Anions by electrostatic force of attraction to form Ionic bond
- Ionic compounds are solid, hard, have high melting and boiling points. They are soluble in water but insoluble in organic solvents. They are good conductor of electricity in molten state and in aqueous solution.
- Covalent Bonding: The chemical bond formed by mutual sharing of equal no. of electrons between two atoms. Covalent bonding is helpful in understanding the formation of the molecules. H_2 , Cl_2 , O_2 and N_2 are such molecules formed by sharing of electrons between similar atoms, while H_2O and HCl compounds formed by sharing of electrons between dissimilar atoms.
- On the basis of sharing of number of electrons by each atom, covalent compounds are classified as single bonded, double bonded and triple bonded. When sharing of one electron takes place from both the atoms, single bond is formed. Like $Cl-Cl$ or Cl_2 and $H-H$ or H_2 .

- Double bond is formed when two similar atoms share two pair of electrons e.g. $O=O$ or O_2 and triple bond is formed when there is sharing of three electrons from each atom. e.g. $N\equiv N$ or N_2 .
- The dissimilar atoms also share electrons but shared pair of electrons shift towards more reactive atom as in HCl and H_2O .
- Covalent compounds mostly have liquid or gaseous state. Some are solid also. They have low melting point, low boiling point. They are insoluble in water but soluble in organic compounds. They are non-conductor of electricity.



Notes

**TERMINAL EXERCISE**

1. Why ionic compounds conduct electricity in aqueous solution?
2. Covalent compounds have low melting point than an ionic compound why?
3. Explain the formation of Na^+ ion from Na atom.
4. How would you explain the bonding in $MgCl_2$?
5. Which of the following statements are correct for ionic compounds:
 - (i) They are insoluble in water.
 - (ii) They are neutral in nature.
 - (iii) They have high melting points.
6. State three characteristic properties of ionic compounds.
7. How does a covalent bond form?
8. What is the number of solvent bonds present in the following molecules?

(i) Cl_2	(ii) N_2	(iii) O_2	(iv) H_2
------------	------------	-------------	------------
9. Classify the following statements as true or false:
 - (i) Ionic compounds contain ions which are held together by weak electrostatic forces.
 - (ii) Ionic compounds have high melting and boiling points.
 - (iii) Covalent compounds are good conductors of electricity.
 - (iv) Solid sodium chloride is a good conductor of electricity.
10. Classify the following compounds as ionic or covalent:

(i) sodium chloride	(ii) calcium chloride
(iii) oxygen	(iv) hydrogen chloride
(v) magnesium oxide	(vi) nitrogen



Notes

- An element 'X' has atomic no. 11 and 'Y' has atomic no. 8. What type of bond they will form? Write the formula of the compound formed by reacting X and Y.
- Name the type of bonds present in H₂O molecule.



ANSWER TO INTEXT QUESTIONS

7.1

- Every atom has tendency to attain 2 or 8 e⁻ in their outermost shell to get stability like noble gases.
- Because they have inert gas configuration which makes it very stable.
- A and B

7.2

- Sodium ion Na⁺ and chloride ion Cl⁻.
- Two (2)
- 18
- Electrostatic force of attraction
- Six

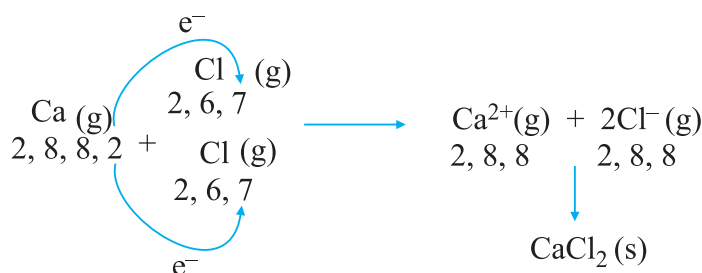
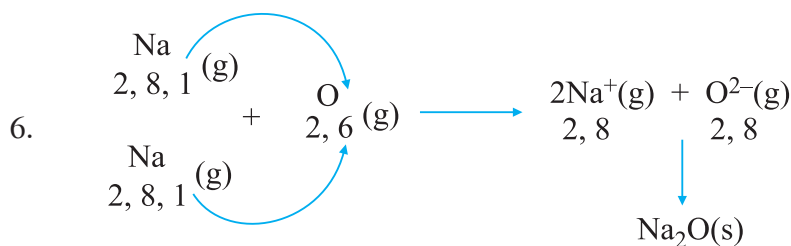

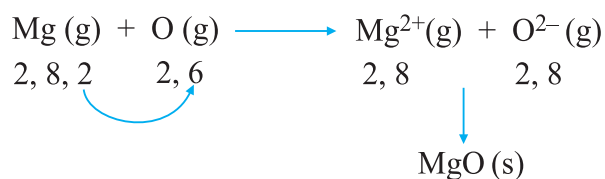

Notes

7. Due to absence of free Na^+ and Cl^- ion.

7.3

1. A covalent bond is formed by sharing of equal no. of electrons between two atoms.

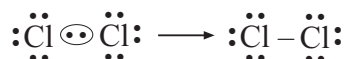
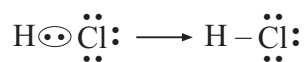

3. (i) 2 (ii) 1 (iii) 2 (iv) 3

4. (i) Gain of $3e^-$

(ii) Gain of $1e^-$

(iii) Loss of $2e^-$

(iv) Loss of $3e^-$

5. Ethyl alcohol do not produce H^+ ion in its aqueous solution, hence does not conduct electricity.



ACIDS, BASES AND SALTS

From generations, our parents have been using tamarind or lemon juice to give shiny look to the copper vessels. Our mothers never store pickles in metal containers. Common salt and sugar has often been used as an effective preservative. How did our ancestors know that tamarind, lemon, vinegar, sugar etc. works effectively? This was common collective wisdom which was passed from generation to generation. These days, bleaching powder, baking soda etc. are commonly used in our homes. You must have used various cleaners to open drains and pipes and window pane cleaners for sparkling glass. How do these chemicals work? In this lesson we will try to find answers to these questions. Most of these examples can be classified as acids, bases or salts. In this unit we shall categorize these substances. We shall study about their characteristic properties. We will also be learning about pH – a measure of acidity and its importance in our life.



OBJECTIVES

After completing this lesson you will be able to:

- *define the terms acid, base, salt and indicator;*
- *give examples of some common household acids, bases, salts and suggest suitable indicators;*
- *describe the properties of acids and bases;*
- *differentiate between strong and weak acids and bases;*
- *explain the role of water in dissociation of acids and bases;*
- *explain the term ionic product constant of water;*
- *define pH;*
- *correlate the concentration of hydrogen ions and pH with neutral, acidic and basic nature of aqueous solutions;*

- recognize the importance of pH in everyday life,;
- define salts and describe their methods of preparation;
- correlate the nature of salt and the pH of its aqueous solution;
- describe the manufacture and use of baking soda, washing soda, plaster of paris and bleaching powder.



Notes

8.1 ACIDS AND BASES

For thousands of years, people have known that vinegar, lemon juice, Amla, tamarind and many other food items taste sour. However, only a few hundred years ago it was proposed that these things taste sour because they contain ‘acids’. The term **acid** comes from Latin term ‘accre’ which means sour. It was first used in the seventeenth century by Robert Boyle to label substances as acids and bases according to the following characteristics:

Acids	Bases
(i) taste sour	(i) taste bitter
(ii) are corrosive to metals	(ii) feel slippery or soapy
(iii) change blue litmus red	(iii) change red litmus blue
(iv) become less acidic on mixing with bases	(iv) become less basic on mixing with acids

While Robert Boyle was successful in characterising acids and bases he could not explain their behaviour on the basis of their chemical structure. This was accomplished by Swedish scientist Svante Arrhenius in the late nineteenth century. He proposed that on dissolving in water, many compounds dissociate and form ions and their properties are mainly the properties of the ions they form. Governed by this, he identified the ions furnished by acids and bases responsible for their characteristic behaviour and gave their definitions.

8.1.1 Acids

An acid is a substance which furnishes hydrogen ions (H^+) when dissolved in water. For example, in its aqueous solution hydrochloric HCl (aq) dissociates as:

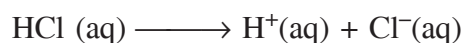

Some examples of acids are:

- (i) Hydrochloric acid (HCl) in gastric juice
- (ii) Carbonic acid (H_2CO_3) in soft drinks
- (iii) Ascorbic acid (vitamin C) in lemon and many fruits

H^+
ACIDS



Notes

- (iv) Citric acid in oranges and lemons
- (v) Acetic acid in vinegar
- (vi) Tannic acid in tea
- (vii) Nitric acid (HNO₃) used in laboratories
- (viii) Sulphuric acid (H₂SO₄) used in laboratories

8.1.2 Bases

A base is a substance which furnishes hydroxide ions (OH⁻) when dissolved in water. For example, sodium hydroxide NaOH (aq), in its aqueous solutions, dissociates as:

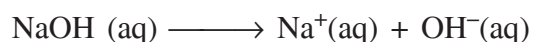

OH⁻
BASE

The term ‘**alkali**’ is often used for water soluble bases.

Some examples of bases are:

- (i) Sodium hydroxide (NaOH) or caustic soda used in washing soaps.
- (ii) Potassium hydroxide (KOH) or potash used in bathing soaps.
- (iii) Calcium hydroxide (Ca(OH)₂) or lime water used in white wash.
- (iv) Magnesium hydroxide (Mg(OH)₂) or milk of magnesia used to control acidity.
- (v) Ammonium hydroxide (NH₄OH) used in hair dyes.

8.1.3 Indicators

You might have seen that the spot of turmeric or gravy on cloth becomes red when soap is applied on it. What do you think has happened? Turmeric has acted as an indicator of base present in soap. There are many substances that show one colour in an acidic medium and another colour in a basic medium. Such substances are called acid-base indicators.

Litmus is a natural dye found in certain lichens. It was the earliest indicator to be used. It shows red colour in acidic solutions and blue colour in basic solutions. Phenolphthalein and methyl orange are some other indicators. The colours of these indicators in acidic, neutral and basic solutions are given below in table 8.1.

Table 8.1 Colours of some indicators in acidic and basic solutions

Indicator	Colour in acidic solutions		Colour in neutral solutions		Colour in basic solutions	
Litmus		red		purple		blue
Phenolphthalein		colourless		colourless		pink
Methyl orange		red		orange		yellow



INTEXT QUESTION 8.1

1. Put the following substances in acid or base bottle.

- Milk of magnesia
- gastric juice in humans
- soft drinks
- lime water
- vinegar
- soap

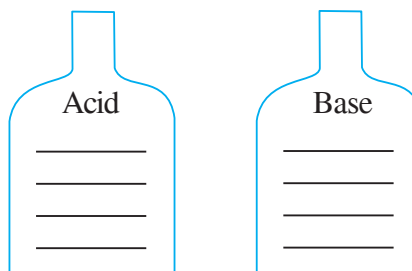

2. What will happen if you add a drop of the following on a cut unripe apple, curd, caustic soda solution and soap solution.

- phenolphthalein
- litmus

Notes



8.2 PROPERTIES OF ACIDS AND BASES

Each substance shows some typical or characteristic properties. We can categorize a substance as an acid or a base according to the properties displayed. Let us learn the characteristic properties of acids and bases.

8.2.1 Properties of Acids

The following are the characteristic properties of acids:

1. Taste

You must have noticed that some of the food items we eat have sour taste. The sour taste of many unripe fruits, lemon, vinegar and sour milk is caused by the acids present in them. Hence, we can say that acids have a sour taste. This is particularly true of dilute acids (see table 8.2).

Table 8.2 Acids present in some common substances

Substance	Acid present
1. Lemon juice	Citric acid and ascorbic acid (vitamin C)
2. Vinegar	Ethanoic acid (commonly called acetic acid)
3. Tamarind	Tartaric acid
4. Sour milk	Lactic acid



Notes



ACTIVITY 8.1

Go to your neighbourhood shop and procure.

1. Packaged Curd
2. Juices in tetra packs

Test these with a litmus paper to find out if these are acidic in nature.

2. Action on Indicators

We have learnt earlier (section 8.1.3) that indicators show different colours in presence of acids and bases. Let us recall the colours of the three commonly used indicators in presence of acids.

Table 8.3 Colours of some indicators in presence of acids.

Indicator	Colour in acidic medium
1. Litmus	Red
2. Phenolphthalein	Colourless
3. Methyl orange	Red

3. Conduction of electricity and dissociation of acids

Do you know that solutions of acids in water (aqueous solutions) conduct electricity? Such solutions are commonly used in car and inverter batteries. When acids are dissolved in water they produce ions which help in conducting the electricity. This process is known as *dissociation*. More specifically, acids produce hydrogen ions (H^+) which are responsible for all their characteristic properties. These ions do not exist as H^+ in the solution but combine with water molecules as shown below:

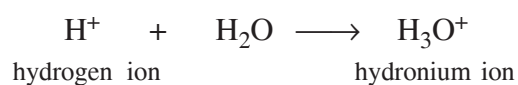

The H_3O^+ ions are called **hydronium ions**. These ions are also represented as $H^+(aq)$.

On the basis of the extent of dissociation occurring in their aqueous solutions, acids are classified as strong and weak acids.

A. Strong and Weak acids

Acids are classified as strong and weak acids and their characteristics are as follow :

Points to ponder

All hydrogen containing compounds are not acids
Although Ethyl alcohol (C_2H_5OH) and glucose ($C_6H_{12}O_6$) contain hydrogen but do not produce H^+ ion on dissolving in water. Their solutions do not conduct electricity and are not acidic.



Notes

Strong Acids	Weak Acids
<p>The acids which completely dissociate in water are called strong acids</p> <p>Nitric acid completely dissociates in water</p> $\text{HNO}_3(\text{aq}) \longrightarrow \text{H}^+(\text{aq}) + \text{NO}_3^-(\text{aq})$ <p>There are only seven strong acids</p> <ol style="list-style-type: none"> 1. HCl Hydrochloric Acid 2. HBr Hydrobromic Acid 3. HI Hydroiodic Acid 4. HClO₄ Perchloric Acid 5. HClO₃ Chloric Acid 6. H₂SO₄ Sulphuric Acid 7. HNO₃ Nitric Acid 	<p>The acids which dissociate partially in water are called weak acids. All organic acids like acetic acid and some inorganic acids are weak acids. Since their dissociation is only partial, it is depicted by double half arrows.</p> $\text{HF}(\text{aq}) \rightleftharpoons \text{H}^+(\text{aq}) + \text{F}^-(\text{aq})$ <p>The double arrows indicates here that</p> <ol style="list-style-type: none"> (i) the aqueous solution of hydrofluoric acid not only contains H⁺ (aq) and F⁻(aq) ions but also the undissociated acid HF(aq). (ii) there is an equilibrium between the undissociated acid HF(aq) and the ions furnished by it, H⁺(aq) and F⁻(aq) <p>Examples:</p> <ol style="list-style-type: none"> (a) CH₃COOH Ethanoic (acetic) acid, (b) HF Hydrofluoric acid (c) HCN Hydrocyanic acid (d) C₆H₅COOH Benzoic acid

4. Reaction of Acids with Metals

The reaction of acids with metals can be studied with the help of the following activity.



ACTIVITY 8.2

This activity may be carried out in the chemistry laboratory of your study centre.

Aim: To study the reaction of acids with metals.



Notes

What is required?

A test tube, zinc granules, dilute H_2SO_4 , match box and a test tube holder.

What to do?

- Add a few zinc granules in a test tube.
- Add dil. sulphuric acid carefully along the sides of the test tube.
- Set the apparatus as shown in the Fig. 8.1.
- Bring a burning match stick near the mouth of the test tube, (Fig. 8.1).

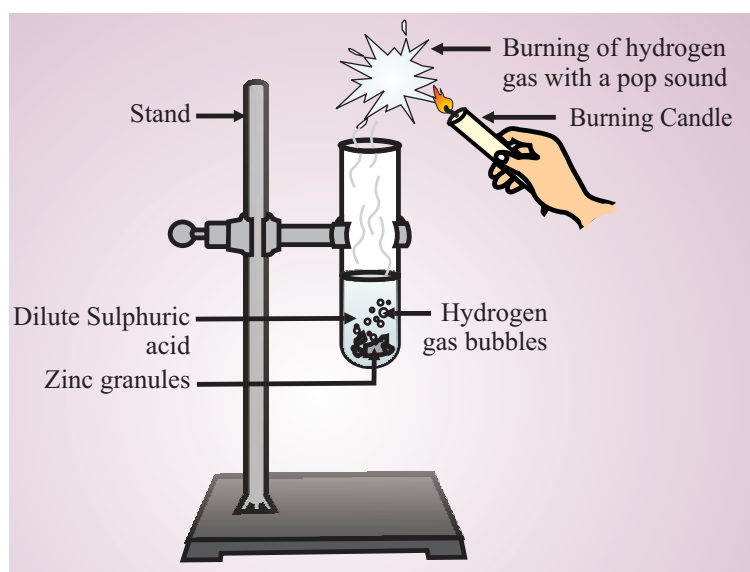

Fig. 8.1: Experiment to study the reaction of dil. H_2SO_4 with zinc. The gas burns with a 'pop' sound when a burning match stick is brought near the mouth of the test tube.

What to observe?

- When dilute sulphuric acid is added to zinc granules, hydrogen gas is formed. The gas bubbles rise through the solution.
- When the burning match stick is brought near the mouth of the test tube the gas in the test tube burns with a 'pop' sound. This confirms that the gas evolved is hydrogen gas.

From this experiment it can be said that dilute sulphuric acid reacts with zinc to produce hydrogen gas. A similar reaction is observed when we use other metals like iron. In general, it can be said that in such reactions metal displaces hydrogen from acids and hydrogen gas is released. The metal combines with the remaining part of the acid and forms a compound called a salt, thus,



For example, the reaction between zinc and dil. sulphuric acid can be written as:

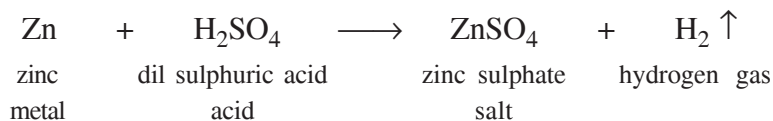

5. Reaction of acids with metal carbonates and hydrogen carbonates

Reaction of acids with metal carbonates and hydrogen carbonates can be studied with the help of activity 8.2.



ACTIVITY 8.3

This experiment may be carried out in the chemistry laboratory of your study centre.

Aim: To study the reaction of acids with metal carbonates and hydrogen carbonates.

What is required?

One test tube, one boiling tube fitted with a cork, thistle funnel and delivery tube, sodium carbonate, sodium hydrogen carbonate, dilute HCl and freshly prepared lime water.

What to do?

- Take the boiling tube and add about 0.5 g sodium carbonate to it.
- Take about 2 mL of freshly prepared lime water in a test tube.

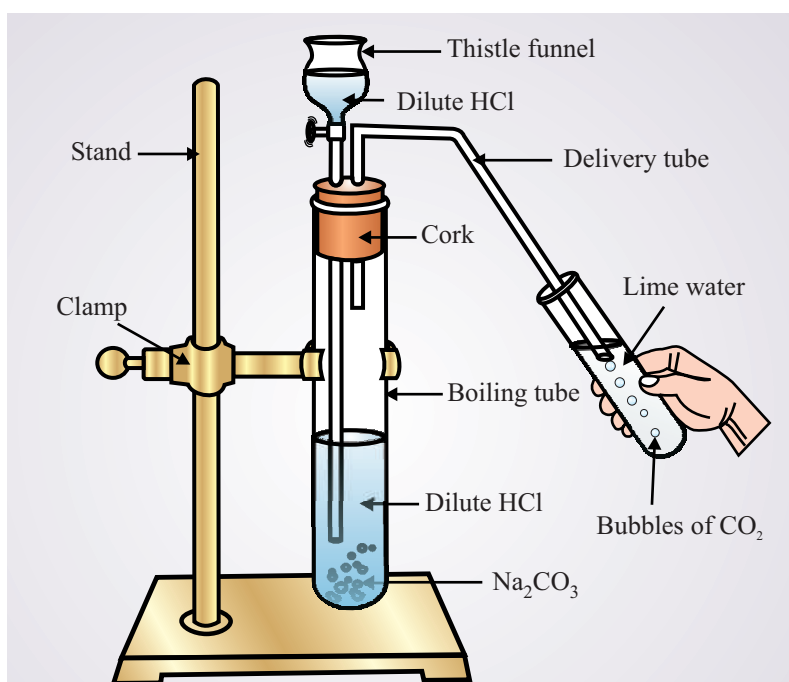

Fig. 8.2: Experimental set up to study the reaction of acids with metal carbonates and hydrogen carbonates



Notes



Notes

- Add about 3 mL dilute HCl to the boiling tube containing sodium carbonate and immediately fix the cork filled with a delivery tube and set the apparatus as shown in the Fig. 8.2.
- Dip the other end of the delivery tube in the lime water as shown in Fig. 8.2.
- Observe the lime water carefully.
- Repeat the activity with sodium hydrogen carbonate.

What to observe?

- When dilute HCl is added to sodium carbonate or sodium hydrogen carbonate, carbon dioxide gas is evolved.
- On passing CO₂ gas, lime water turns milky.
- On passing the excess of CO₂ gas, lime water becomes clear again.

From the above activity it can be concluded that if sodium carbonate or sodium hydrogen carbonate react with dilute hydrochloric acid, carbon dioxide gas is evolved. The respective reactions are:

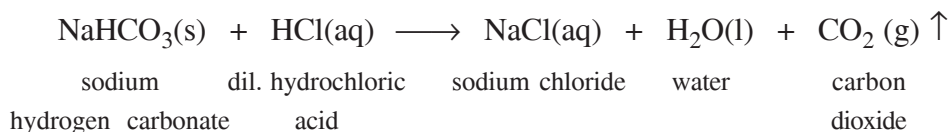
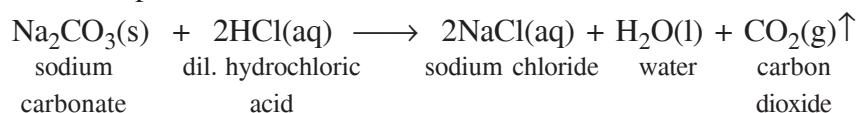

On passing the evolved carbon dioxide gas through lime water, Ca(OH)₂, the later turns milky due to the formation of white precipitate of calcium carbonate

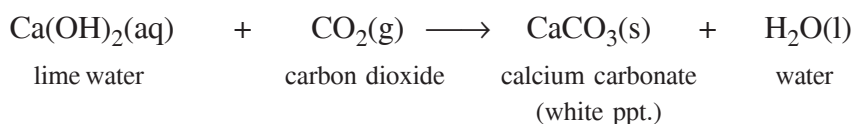

If excess of carbon dioxide gas is passed through lime water, the white precipitate of calcium carbonate disappears due to the formation of water soluble calcium hydrogen carbonate.

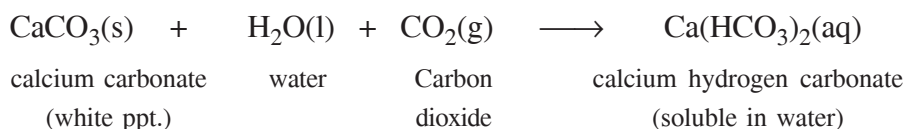

Thus, we can summarize that,

Metal carbonate + Acid \longrightarrow Salt + Water + Carbon dioxide
 and Metal hydrogen carbonate + Acid \longrightarrow Salt + Water + Carbon dioxide

6. Reaction of Acids with metal oxides

We can study the reaction of acids with metal oxides with the help of activity 8.4.

**ACTIVITY 8.4**

This activity may be carried out in the chemistry laboratory of your study centre.

Aim : To study the reaction of acids with metal oxides.

What is required?

A beaker, glass rod, copper oxide and dilute hydrochloric acid.

What to do?

- Take a small amount of black copper oxide in a beaker.
- Add about 10 mL of dilute hydrochloric acid and stir the solution gently with the help of a glass rod. [Fig. 8.3(a)].
- Observe the beaker as the reaction occurs. [Fig. 8.3(b)].

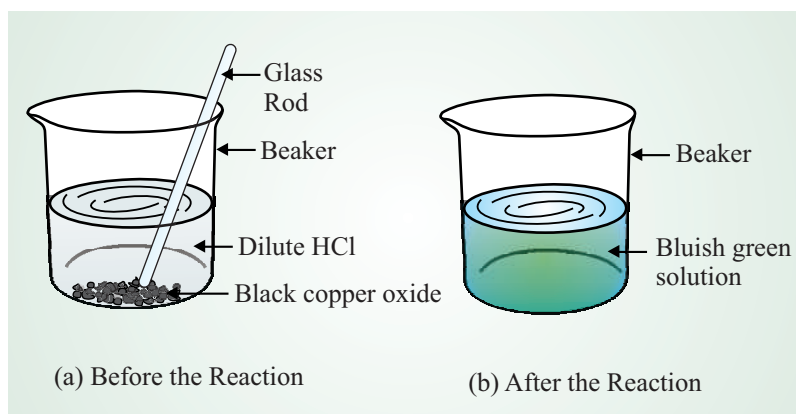

Fig. 8.3 Reaction between dilute hydrochloric acid and copper oxide (a) before reaction black particles of copper oxide in transparent dilute hydrochloric acid and (b) after reaction bluish green solution.

What to Observe?

- When a mixture of dilute HCl and copper oxide is mixed, the black particles of copper oxide can be seen suspended in colourless dilute hydrochloric acid.
- As the reaction proceeds, the black particles slowly dissolve and the colour of the solution becomes bluish green due to the formation of copper (II) chloride (cupric chloride) – a salt.



Notes



Notes

From this activity, we can conclude that the reaction between copper oxide and dilute hydrochloric acid results in the formation of copper (II) chloride (cupric chloride) which is a salt of copper. This salt forms bluish green solution. The reaction is:

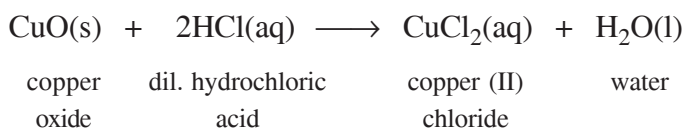

Many other metal oxides like magnesium oxide (MgO) and calcium oxide (CaO) or quick lime also react with acid in a similar way. For example,

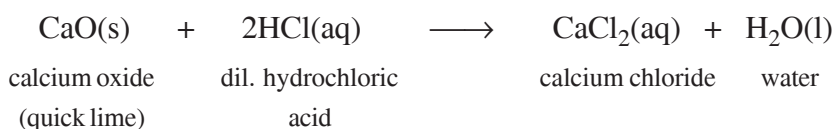

So, we can summarize with a general reaction between metal oxides and acids as:



7. Reaction of acids with bases

Let us study the reaction of acids with bases with the help of the following activity.



ACTIVITY 8.5

This activity may be carried out in the chemistry laboratory of your study centre.

Aim : To study the reaction between acids and bases.

What is required?

A test tube, dropper, phenolphthalein indicator, solution of sodium hydroxide and dil. hydrochloric acid.

What to do?

- Take about 2 mL solution of sodium hydroxide in a test tube.
- Add a drop of phenolphthalein indicator to it and observe the colour.
- With the help of a dropper add dil. HCl dropwise and stir the solution constantly till the colour disappears.
- Now add a few drops of NaOH solution. The colour of the solution is restored.

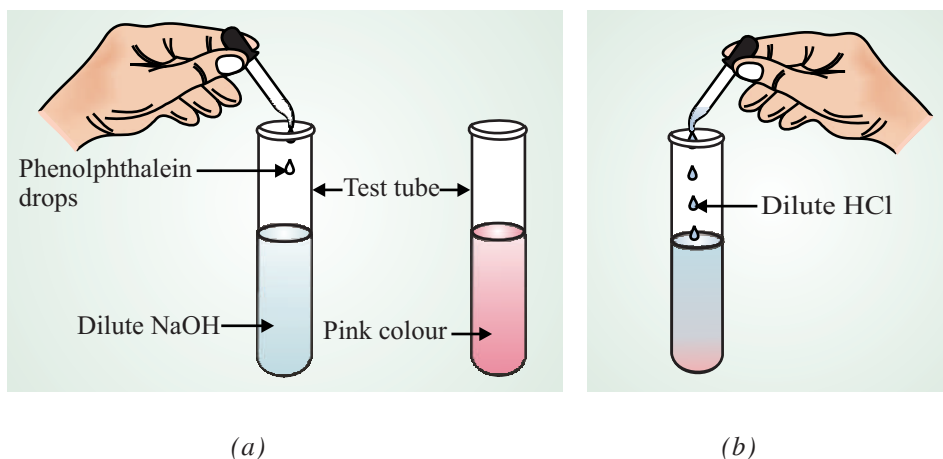
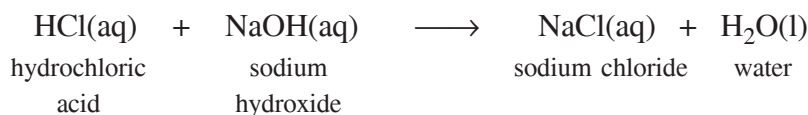

Fig. 8.4: Reaction between NaOH and HCl (a) Pink colour solution containing NaOH solution and a drop of phenolphthalein (b) The solution becomes colourless on addition of dil HCl

What to Observe?

- When a drop of phenolphthalein is added to a solution of NaOH the solution becomes pink in colour.
- On adding HCl, the colour of the solution fades due to the reaction between HCl and NaOH.
- When whole of NaOH has reacted with HCl, the solution becomes colourless.
- On adding NaOH, the solution becomes pink again.

From this activity, we can see that when dilute HCl is added to NaOH solution, the two react with each other. When sufficient HCl is added, the basic properties of NaOH and acidic properties of HCl disappear. The process is therefore called **neutralization**. It results in the formation of salt and water. The reaction between hydrochloric acid and sodium hydroxide forms sodium chloride and water.



Similar reactions occur with other acids and bases. For example, sulphuric acid and potassium hydroxide react to form potassium sulphate and water.

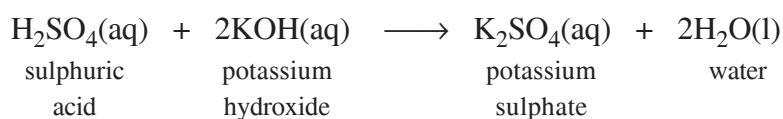

In general, the reaction between an acid and a base can be written as:



Notes



Notes

8. Corrosive Nature

The ability of acids to attack various substances like metals, metal oxides and hydroxides is referred to as their corrosive nature. (It may be noted here that the term 'corrosion' is used with reference to metals and refers to various deterioration processes (oxidation) they undergo due to their exposure to environment). Acids are corrosive in nature as they can attack variety of substances.

'Strong' is different from 'corrosive'

Corrosive action of acids is not related to their strength. It is related to the negatively charged part of the acid. For example, hydrofluoric acid, (HF) is a weak acid. Yet, it is so corrosive that it attacks and dissolves even glass. The fluoride ion attacks the silicon atom in silica glass while the hydrogen ion attacks the oxygen of silica (SiO_2) in the glass.

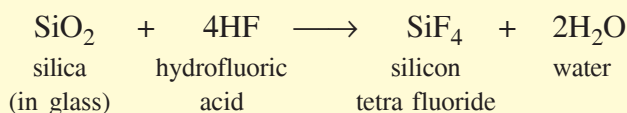

8.2.2 Properties of Bases

The following are the characteristic properties of bases:

1. Taste and touch

Bases have a bitter taste and their solutions are soapy to touch.

2. Action on Indicators

As seen earlier (section 8.1.3) each indicator shows characteristic colour in presence of bases. The colours shown by three commonly used indicators in presence of bases are listed below for easy recall.

Warning

Although we talk of 'taste' of acids and bases, it is not advisable to taste any acid or base. Most of them are harmful. Similarly touching the solutions of strong acids and bases should be avoided. They may harm the skin.

Table 8.3 Colours of some common indicators in basic solution

Indicator	Colour in basic medium
1. Litmus	Blue
2. Phenolphthalein	Pink
3. Methyl orange	Yellow

3. Conduction of electricity and dissociation of bases

Aqueous solutions (solution in water) of bases conduct electricity which is due to the formation of ions. Like acids, bases also dissociate on dissolving in water. Bases produce hydroxyl ions (OH^-) which are responsible for their characteristic properties.

The bases which are soluble in water and give OH^- ions in their aqueous solution are called **alkalies**. *All alkalies are bases but all bases are not alkalies.* On the basis of the extent of dissociation occurring in their solution, bases are classified as strong and weak bases.

A. Strong and Weak Bases

Bases are classified as strong and weak bases and their characteristics are as follow :

Strong Bases	Weak Bases
<p>These bases are completely dissociated in water to form the cation and hydroxide ion (OH^-). For example, potassium hydroxide dissociates as</p> $\text{KOH(aq)} \longrightarrow \text{K}^{\text{(aq)}} + \text{OH}^{\text{(aq)}}$ <p>There are only eight strong bases. These are the hydroxides of the elements of the Groups 1 and 2 of the periodic table</p> <ol style="list-style-type: none"> LiOH Lithium hydroxide NaOH Sodium hydroxide KOH Potassium hydroxide RbOH Rubidium hydroxide CsOH Caesium hydroxide Ca(OH)_2 Calcium hydroxide Sr(OH)_2 Strontium hydroxide Ba(OH)_2 Barium hydroxide 	<p>Weak bases do not furnish OH^- ions by dissociation. They react with water to furnish OH^- ions.</p> $\text{NH}_3(\text{g}) + \text{H}_2\text{O}(\text{l}) \longrightarrow \text{NH}_4\text{OH}$ $\text{NH}_4\text{OH}(\text{aq}) \rightleftharpoons \text{NH}_4^{\text{(aq)}} + \text{OH}^{\text{(aq)}}$ <p style="text-align: center;">or</p> $\text{NH}_3(\text{g}) + \text{H}_2\text{O}(\text{l}) \rightleftharpoons \text{NH}_4^{\text{(aq)}} + \text{OH}^{\text{(aq)}}$ <p>The reaction resulting in the formation of OH^- ions does not go to completion and the solution contains relatively low concentration of OH^- ions. The two half arrows are used in the equation to indicate that equilibrium is reached before the reaction is completed. Examples of weak bases (i) NH_4OH, (ii) Cu(OH)_2 (iv) Cr(OH)_3 (v) Zn(OH)_2 etc.</p>

4. Reaction of bases with metals

Like acids, bases also react with active metals liberating hydrogen gas. Such reactions can also be studied with the help of activity 8.2 given earlier. For example, sodium hydroxide reacts with zinc as shown below:

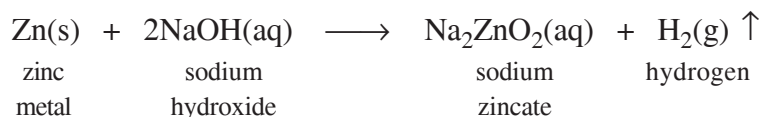

5. Reaction of Bases with non-metal oxides

Bases react with oxides of non-metals like CO_2 , SO_2 , SO_3 , P_2O_5 etc. to form salt and water.



Notes



Notes

For example,

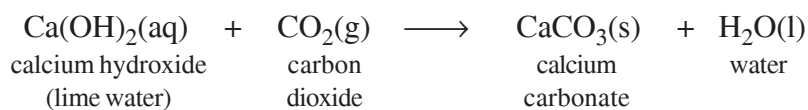

The reaction can be written in a general form as:



6. Reaction of bases with acids

We have learnt the mutual reaction between acids and bases in previous section. Such reactions are called *neutralization* reactions and result in the formation of salt and water. The following are some more examples of neutralization reactions:

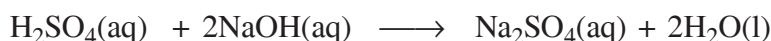

Caustic nature

Strong bases like sodium hydroxide and potassium hydroxide are corrosive towards organic matter and break down the proteins of the skin and flesh to a pasty mass. This action is called caustic action and it is due to this property that sodium hydroxide is called 'caustic soda' and potassium hydroxide is called 'caustic potash'. The term 'caustic' is not used for corrosive action of acids.



INTEXT QUESTIONS 8.2

- Name the substances in which the following acids are present:
 - Ethanoic acid
 - Tartaric acid
- Which of these acids would be partially dissociated in their aqueous solution?
 - HBr
 - HCN
 - HNO₃
 - C₂H₅COOH
- An acid reacts with a substance X with liberation of a gas which burns with a 'pop' sound when a burning match stick is brought near it. What is the nature of X?
- An acid reacts with a substance Z with the liberation of CO₂ gas. What can be the nature of Z?
- Which of the following oxides will react with a base?
 - CaO
 - SO₂

8.3 WATER AND DISSOCIATION OF ACIDS AND BASES

In the previous sections, we have learnt that a substance is an acid if it furnishes H^+ ions in its aqueous solution and a base if it furnishes OH^- ions. Water plays very important role in these processes, we shall learn about it in this section.

8.3.1 Role of water in dissociation of acids and bases

If a dry strip of blue litmus paper is brought near the mouth of the test tube containing dry HCl gas, its colour does not change. When it is moistened with a drop of water and again brought near the mouth of the test tube, its colour turns red. It shows that there are no H^+ ions in dry HCl gas. Only when it dissolves in water, H^+ ions are formed and it shows its acidic nature by turning the colour of the blue litmus paper to red.

A similar behavior is exhibited by bases. If we take a pallet of dry NaOH in dry atmosphere and quickly bring a dry strip of red litmus paper in its contact, no colour change is observed. NaOH is a **hygroscopic** compound and soon absorbs moisture from air and becomes wet. When this happens, the colour of the red litmus paper immediately changes to blue. Thus in dry solid NaOH although OH^- ions are present but they are not free and do not show basic nature on coming in contact with water, OH^- ions become free and show the basic nature by changing red litmus blue. From the above discussion, it is clear that acidic and basic characters of different substances can be observed only when they are dissolved in water.

Warning

Dissolution of H_2SO_4 in water is highly exothermic process. Therefore, to prepare an aqueous solution, conc. sulphuric acid is added slowly to water with constant stirring. Water is **never** added to conc. sulphuric acid as huge amount of heat is liberated. Due to that spattering occurs and the acid can cause serious burns on skins or damage the items on which it falls.

- When an acid like sulphuric acid or a base like sodium hydroxide is dissolved in water, the solution that is formed is hotter. It shows that the dissolution process is **exothermic**. A part of the thermal energy which is released during the dissolution process is used up in overcoming the forces holding the hydrogen atom or hydroxyl group in the molecule of the acid or the base in breaking the chemical bond holding them and results in the formation of free $H^+(aq)$ and $OH^-(aq)$ ions.
- Many bases are ionic compounds and consist of ions even in the solid state. For example sodium hydroxide consists of Na^+ and OH^- ions. These ions are held very tightly due to the strong electrostatic forces between the oppositely charged ions. Presence of water as a medium (solvent) weakens these forces greatly and the ions become free to dissolve in water.



Notes



Notes

8.3.2 Self dissociation of water

Water plays an important role in acid base chemistry. We have seen that it helps in the dissociation of acids and bases resulting in the formation of $\text{H}^+(\text{aq})$ and $\text{OH}^-(\text{aq})$ ions respectively. Water itself undergoes dissociation process which is called 'self-dissociation of water'. Let us learn about it.

Self-dissociation of water

Water dissociates into $\text{H}^+(\text{aq})$ and $\text{OH}^-(\text{aq})$ ions as:



The dissociation of water is extremely small and only about two out of every billion (10^9) water molecules are dissociated at 25°C . As a result, the concentrations of $\text{H}^+(\text{aq})$ and $\text{OH}^-(\text{aq})$ ions formed is also extremely low. At 25°C (298K),

$$[\text{H}^+] = [\text{OH}^-] = 1.0 \times 10^{-7} \text{ mol L}^{-1}$$

Here, square brackets denote the molar concentration of the species enclosed within. Thus, $[\text{H}^+]$ denotes the concentration of $\text{H}^+(\text{aq})$ ions in moles per litre and $[\text{OH}^-]$ the concentration of $\text{OH}^-(\text{aq})$ ions in moles per litre.

It must be noted here that in pure water and in all aqueous **neutral solutions**,

$$[\text{H}^+] = [\text{OH}^-]$$

Also, in pure water as well as in all aqueous solutions at a given temperature, product of concentrations of $\text{H}^+(\text{aq})$ and $\text{OH}^-(\text{aq})$ always remains constant. This product is called 'ionic product of water' and is given the symbol K_w . It is also called **ionic product constant of water**. Thus,

$$K_w = [\text{H}^+] [\text{OH}^-]$$

At 25°C (298 K), in pure water, K_w can be calculated as:

$$\begin{aligned} K_w &= (1.0 \times 10^{-7}) \times (1.0 \times 10^{-7}) \\ &= 1.0 \times 10^{-14} \end{aligned}$$

8.3.3 Neutral, acidic and basic solutions

We have seen that in pure water $\text{H}^+(\text{aq})$ and $\text{OH}^-(\text{aq})$ ions are produced in equal numbers as a result of dissociation of water and therefore, their concentrations are also equal i.e.

$$[\text{H}^+] = [\text{OH}^-]$$

(i) Neutral solutions

In all neutral aqueous solutions, the concentrations of $\text{H}^+(\text{aq})$ and $\text{OH}^-(\text{aq})$ ions remains equal i.e.

$$[\text{H}^+] = [\text{OH}^-]$$

In other words the neutral solution is the one in which the concentrations of H^+ and OH^- ions are equal.

(ii) Acidic solutions

Acids furnish $\text{H}^+(\text{aq})$ ions in their solutions resulting in increase in their concentration. Thus, in acidic solutions



Notes

$$[\text{H}^+] > [\text{OH}^-]$$

and

$$[\text{H}^+] > 1.0 \times 10^{-7} \text{ mol L}^{-1}$$

In other words the acidic solution is the one in which the concentration of $\text{H}^+(\text{aq})$ is greater than that of $\text{OH}^-(\text{aq})$ ions.

We have seen earlier that the ionic product of water K_w is constant at a given temperature. It can remain so only if the concentration of $\text{OH}^-(\text{aq})$ ions decreases.

$$[\text{OH}^-] < 10^{-7} \text{ mol L}^{-1}$$

(iii) Basic solutions

Bases furnish $\text{OH}^-(\text{aq})$ ions in their solutions. This results in an increase in their concentration. Therefore, in basic solution

$$[\text{OH}^-] > [\text{H}^+]$$

and

$$[\text{OH}^-] > 1.0 \times 10^{-7} \text{ mol L}^{-1}$$

In other words, the basic solution is the one in which the concentration of $\text{H}^+(\text{aq})$ ions is smaller than that of $\text{OH}^-(\text{aq})$ ions.

Here also, because of constancy of ionic product of water K_w , the concentration of $\text{H}^+(\text{aq})$ decreases. Thus

and

$$[\text{H}^+] < 1.0 \times 10^{-7} \text{ mol L}^{-1}$$

We may summarize the nature of aqueous solution in terms of concentration of hydrogen ions $\text{H}^+(\text{aq})$ as shown in table 8.3.

Table 8.3 Concentration of $\text{H}^+(\text{aq})$ ions in different types of aqueous solutions

Nature of solution	Concentration of H^+ ions at 25°C (298 K)
Neutral	$[\text{H}^+] = 1.0 \times 10^{-7} \text{ mol L}^{-1}$
Acidic	$[\text{H}^+] > 1.0 \times 10^{-7} \text{ mol L}^{-1}$
Basic	$[\text{H}^+] < 1.0 \times 10^{-7} \text{ mol L}^{-1}$



INTEXT QUESTIONS 8.3

- Why does the colour of dry blue litmus paper remains unchanged even when it is brought in contact with HCl gas?
- How does water help in dissociation of acids and bases?
- Identify the nature of the following aqueous solutions (whether acidic, basic or neutral)
 - Solution A: $[\text{H}^+] < [\text{OH}^-]$
 - Solution B: $[\text{H}^+] > [\text{OH}^-]$
 - Solution C: $[\text{H}^+] = [\text{OH}^-]$



Notes

8.4 pH AND ITS IMPORTANCE

When dealing with range of concentrations (such as these of $\text{H}^+(\text{aq})$ ions) that spans many powers of ten, it is convenient to represent them on a more compressed logarithmic scale. By convention, we use the **pH scale** for denoting the concentration of hydrogen ions. **pH** notation was devised by the Danish biochemist Soren Sorensen in 1909. The term pH means “power of hydrogen”.

The pH is the logarithm (see box) of the reciprocal of the hydrogen ion concentration. It is written as:

$$\text{pH} = \log \left[\frac{1}{[\text{H}^+]} \right]$$

Alternately, the pH is the negative logarithm of the hydrogen ion concentration i.e

$$\text{pH} = -\log [\text{H}^+].$$

Because of the negative sign in the expression, if $[\text{H}^+]$ increases, pH would decrease and if it decreases, pH would increase.

In pure water at 25° (298 K)

$$[\text{H}^+] = 1.0 \times 10^{-7} \text{ mol L}^{-1}$$

$$\log[\text{H}^+] = \log(10^{-7}) = -7$$

$$\text{and } \text{pH} = -\log[\text{H}^+] = -(-7)$$

$$\text{pH} = 7$$

Since in pure water at 25°C (298 K)

$$[\text{OH}^-] = 1.0 \times 10^{-7} \text{ mol L}^{-1}$$

$$\text{Also, } \text{pOH} = 7$$

$$\text{Since, } K_w = 1.0 \times 10^{-14}$$

$$\text{p}K_w = 14$$

The relationship between $\text{p}K_w$, pH and pOH is

$$\text{p}K_w = \text{pH} + \text{pOH}$$

at 25°C (298 K)

$$14 = \text{pH} + \text{pOH}$$

Logarithm

Logarithm is a mathematical function

$$\text{If } x = 10^y$$

$$\text{then } y = \log_{10}x$$

Here $\log_{10}x$ mean log of x to the base 10. Usually, the base 10 is omitted in the notation thus, $y = \log x$.

$$\begin{aligned} \text{e.g. } \log 10^3 &= 3 \times \log 10 \\ &= 3 \times 1 = 3 \end{aligned}$$

$$\begin{aligned} \log 10^{-5} &= -5 \times \log 10 \\ &= -5 \times 1 \\ &= -5 \end{aligned}$$

$$\text{Note : } \log 10 = 1$$



Notes

8.4.1 Calculations based on pH concept

In the last section, we learned the concept of pH and its relationship with hydrogen ion or hydroxyl ion concentration. In this section, we shall use these relations to perform some calculations.

The method of calculation of pH used in this unit are valid for (i) solutions of *strong* acids and bases only and (ii) the solutions of acids or bases should not be extremely dilute and the concentrations of acids and bases *should not be less than* $10^{-6} \text{ mol L}^{-1}$.

Example 8.1: Calculate the pH of 0.001 molar solution of HCl.

Solution: HCl is a strong acid and is completely dissociated in its solutions according to the process:



From this process it is clear that one mole of HCl would give one mole of $\text{H}^{\text{+}}$ ions. Therefore, the concentration of $\text{H}^{\text{+}}$ ions would be equal to that of HCl i.e. 0.001 molar or $1.0 \times 10^{-3} \text{ mol L}^{-1}$.

$$\begin{aligned} \text{Thus,} \quad [\text{H}^{\text{+}}] &= 1 \times 10^{-3} \text{ mol L}^{-1} \\ \text{pH} &= -\log[\text{H}^{\text{+}}] = -(\log 10^{-3}) \\ &= -(-3 \times \log 10) = -(3 \times 1) = 3 \end{aligned}$$

$$\text{Thus,} \quad \text{pH} = 3$$

Example 8.2: What would be the pH of an aqueous solution of sulphuric acid which is $5 \times 10^{-5} \text{ mol L}^{-1}$ in concentration.

Solution: Sulphuric acid dissociates in water as:



Each mole of sulphuric acid gives two mole of $\text{H}^{\text{+}}$ ions in the solution. One litre of $5 \times 10^{-5} \text{ mol L}^{-1}$ solution contains 5×10^{-5} moles of H_2SO_4 which would give $2 \times 5 \times 10^{-5} = 10 \times 10^{-5}$ or 1.0×10^{-4} moles of $\text{H}^{\text{+}}$ ion in one litre solution. Therefore,

$$\begin{aligned} [\text{H}^{\text{+}}] &= 1.0 \times 10^{-4} \text{ mol L}^{-1} \\ \text{pH} &= -\log[\text{H}^{\text{+}}] = -\log 10^{-4} = -(-4 \times \log 10) \\ &= -(-4 \times 1) = 4 \end{aligned}$$

Example 8.3: Calculate the pH of 1×10^{-4} molar solution of NaOH.

Solution: NaOH is a strong base and dissociate in its solution as:





Notes

One mole of NaOH would give one mole of OH⁻ ions. Therefore,

$$[\text{OH}^-] = 1 \times 10^{-4} \text{ mol L}^{-1}$$

$$\begin{aligned} \text{pOH} &= -\log[\text{OH}^-] = -\log \times 10^{-4} = -(-4) \\ &= 4 \end{aligned}$$

Since $\text{pH} + \text{pOH} = 14$

$$\begin{aligned} \text{pH} &= 14 - \text{pOH} = 14 - 4 \\ &= 10 \end{aligned}$$

Example 8.4: Calculate the pH of a solution in which the concentration of hydrogen ions is $1.0 \times 10^{-8} \text{ mol L}^{-1}$.

Solution: Here, although the solution is extremely dilute, the concentration given is *not of acid or base* but that of H⁺ ions. Hence, the pH can be calculated from the relation:

$$\text{pH} = -\log[\text{H}^+]$$

$$\text{given } [\text{H}^+] = 1.0 \times 10^{-8} \text{ mol L}^{-1}$$

$$\begin{aligned} \therefore \text{pH} &= -\log 10^{-8} = -(-8 \times \log 10) \\ &= -(-8 \times 1) = 8 \end{aligned}$$

8.4.2 pH Scale

The pH scale ranges from 0 to 14 on this scale. pH 7 is considered neutral, below 7 acidic and above 7 basic. Farther from 7, more acidic or basic the solution is. The scale is shown below in Fig. 8.5.

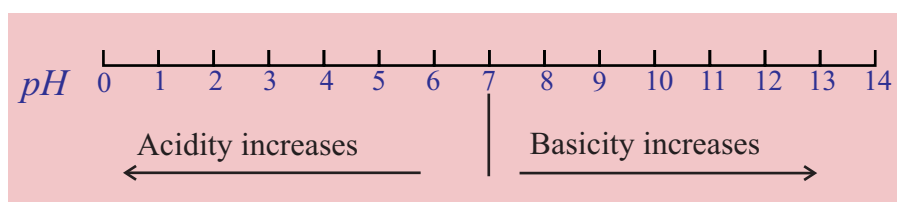

Fig. 8.5: The pH scale

We have learnt earlier that the sum of pH and pOH of any aqueous solution remains constant. Therefore, when one increases the other decreases. This relationship is shown in Fig. 8.6

$$\text{pH} + \text{pOH} = 14$$

Fig. 8.6: Relationship between pH and pOH at 25°C.

pH of some common substances is shown in table 8.5.

Table 8.5: pH of some common acids and bases

Common Acids	pH	Common Bases	pH
HCl (4%)	0	Blood plasma	7.4
Stomach acid	1	Egg white	8
Lemon juice	2	Sea water	8
Vinegar	3	Baking soda	9
Oranges	3.5	Antacids	10
Soda, grapes	4	Ammonia water	11
Sour milk	4.5	Lime water	12
Fresh milk	5	Drain cleaner	13
Human saliva	6-8	Caustic soda 4% (NaOH)	14
Pure water	7		



Notes

8.4.3 Determination of pH

pH of a solution can be determined by using proper indicator or with the help of a pH meter. The latter is a device which gives accurate value of pH. You will study more about it in higher classes. We shall discuss here the use of indicators for finding out the pH of a solution.

Universal Indicator/pH paper.

It is a mixture of a number of indicators. It shows a specific colour at a given pH. A colour guides is provided with the bottle of the indicator or the strips of paper impregnated with it which are called pH paper strips. The test solution is tested with a drop of the universal indicator, or a drop of the test solution is put on pH paper. The colour of the solution on the pH paper is compared with the colour chart/guard and pH is read from it. The pH values thus obtained are only approximate values.



Fig. 8.7: Colour chart/guide of universal indicator/pH paper.

8.4.2 Importance of pH in everyday life

pH plays a very important role in our everyday life. Some such examples are described here.

(a) pH in humans and animals

Most of the biochemical reactions taking place in our body are in a narrow pH range of 7.0 to 7.8. Even a small change in pH disturbs these processes.



Notes

(b) Acid Rain

When the pH of rain water falls below 5.6, it is called **acid rain**. When acid rain flows into rivers, the pH of the river water also falls and it become acidic. As a result, the survival of aquatic life become difficult.

(c) pH in plants

Plants have a healthy growth only when the soil has a specific pH range which should be neither highly alkaline nor highly acidic.

(d) In digestive system

Our stomach produce hydrochloric acid which helps in digestion of food. When we eat spicy food, stomach produces too much of acid which causes 'acidity' i.e. irritation and sometimes pain too. To get rid of this we use 'antacids' which are bases like 'milk of magnesia' (suspension of magnesium hydroxide in water).

(e) Self defence of animals and plants

Bee sting causes severe pain and burning sensation. It is due to the presence of methanoic acid in it. Use of a mild base like baking soda can provides relief from pain.

Some plants like 'nettle plant' have fine stinging hair which inject methanoic acid into the body of any animal or human being that comes in its contact. This causes severe pain and buring sensation. The leaves of dock plant that grows near the nettle plant when rubbed on the affected area provides relief.

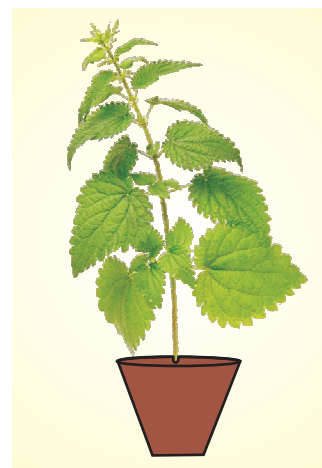

Fig. 8.8 Nettle plant

(f) Tooth decay

Tooth enamel is made of calcium phosphate which is the hardest substance in our body and can withstand the effect of various food articles that we eat. If mouth is not washed properly after every meal, the food particles and sugar remaining in the mouth undergoes degradation due to the bacterial present in the mouth. This process produces acids and the pH goes below 5.5. The acidic condition thus created corrode the tooth enamel and in the long run can result in tooth decay.

**INTEXT QUESTIONS 8.4**

1. pOH of a solution is 5.2. What is its pH. Comment on the nature (acidic, basic or neutral) of this solution.
2. pH of a solution is 9. What is the concentration of H^+ ions in it.

3. What is the nature (whether acidic, basic or neutral) of the following solutions?

- (a) Solution A: $\text{pH} = \text{pOH}$
 (b) Solution B: $\text{pH} > \text{pOH}$
 (c) Solution C: $\text{pH} < \text{pOH}$



Notes

8.5 SALTS

Salts are ionic compounds made of a cation other than H^+ ion and an anion other than OH^- ion.

8.5.1 Formation of salts

Salts are formed in many reactions involving acids and bases.

1. By Neutralization of acids and bases

Salts are the product (besides water) of a neutralization reaction.

For example,

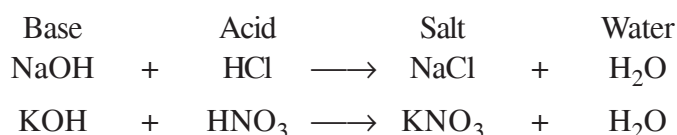

In all the above cases we can see that the positively charged cation of the salt comes from the base. Therefore, it is called the 'basic radical'. The negatively charged anion of the salt comes from the acid. It is therefore, called the 'acid radical' of the salt. For example, in the salt NaCl , the cation Na^+ comes from the base NaOH and is its basic radical and the anion Cl^- comes from the acid HCl and is its 'acid radical'.

2. By action of acids on metals

In a reaction between an acid and a metal, salt is produced along with hydrogen,

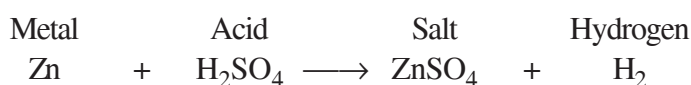

3. By action of acids on metal carbonates and hydrogen carbonates

Salts are produced in reactions between acids and metal carbonates and hydrogen carbonates (bicarbonates) along with water and carbon dioxide.

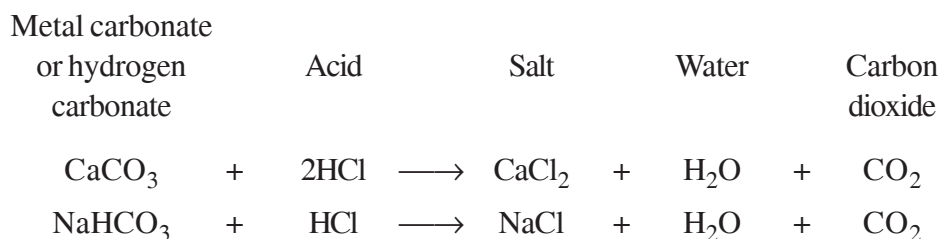



Notes

Type of salt and the nature of its aqueous solution:

	Salt of		Nature of Salt Solution	pH (at 25°C)
	Acid	Base		
1.	Strong	Strong	Neutral	pH = 7
2.	Weak	Strong	Basic	pH > 7
3.	Strong	Weak	Acidic	pH < 7
4.	Weak	Weak	More information required	–

8.6 SOME COMMONLY USED SALTS

A large number of salts are used in our homes and industry for various purposes. In this section we would learn about some such salts.

8.6.1 Baking soda

You must have seen your mother using baking soda while cooking some ‘dals’. If you ask her why does she use it, she would tell that it helps in cooking some items faster which otherwise would take much longer time. Chemically baking soda is sodium hydrogen carbonate, NaHCO_3 .

(a) Manufacture

Baking soda is manufactured by Solvay’s process. It is mainly used for manufacturing washing soda but baking soda is obtained as an intermediate.

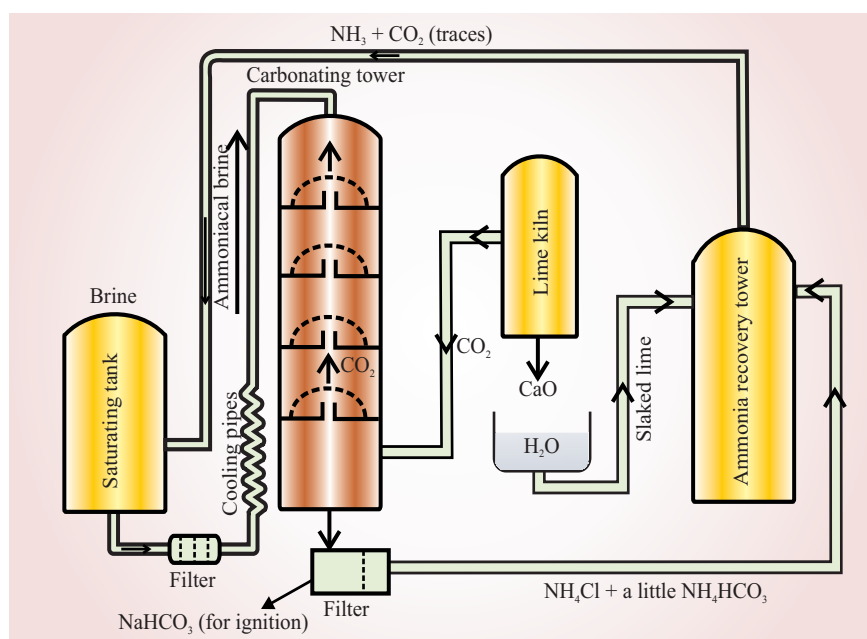

Fig. 8.9 Solvay’s process for manufacturing of Baking soda

Raw materials required

The raw materials required to manufacture washing soda are:

- Lime stone which is calcium carbonate, CaCO_3
- Sodium chloride (NaCl) in the form of brine(Conc. NaCl Solution)
- Ammonia (NH_3)

Process

In Solvay's process, carbon dioxide is obtained by heating limestone strongly,

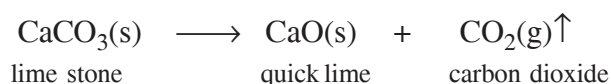

It is then passed through cold brine (a concentrated solution of NaCl in water) which has previously been saturated with ammonia,

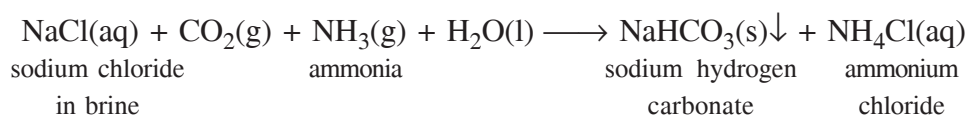

NaHCO_3 is sparingly soluble in water and crystallises out as white crystals. Its solution in water is basic in nature. It is a mild and non-corrosive base.

Action of heat: On heating, sodium hydrogen carbonate is converted into sodium carbonate and carbon dioxide is given off,

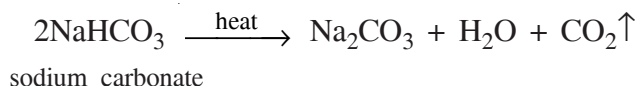
**(b) Use**

1. Used for cooking of certain foods.
2. For making **baking power** (a mixture of sodium hydrogen carbonate and tartaric acid). On heating during baking, baking soda gives off carbon dioxide. It is this carbon dioxide which raises the dough. The sodium carbonate produced on heating the baking soda gives a bitter taste. Therefore, instead of using the baking soda alone, baking powder is used. The tartaric acid present in it neutralises the sodium carbonate to avoid its bitter taste. Cakes and pastries are made fluffly and soft by using baking powder.
3. In medicines
Being a mild and non-corrosive base, baking soda is used in medicines to neutralise the excessive acid in the stomach and provide relief. Mixed with solid edible acids such as citric or tartaric acid, it is used in effervescent drinks to cure indigestion.
4. In soda acid fire extinguishers



Notes



Notes

8.6.2 Washing soda

Washing soda is used for washing of clothes. It is mainly because of this chemical that the clothes washed by a washerman appear so white. Chemically, washing soda is sodium carbonate decahydrate, $\text{Na}_2\text{CO}_3 \cdot 10\text{H}_2\text{O}$.

(a) Manufacture

Washing soda is manufactured by Solvay's process. We have already learnt about the raw materials required and part of the process in the manufacture of baking soda. Sodium carbonate is obtained by calcination (strong heating in a furnace) of sodium hydrogen carbonate and then recrystallising from water:

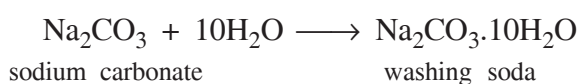

(b) Uses

1. It is used in the manufacture of caustic soda, glass, soap powders, borax and in paper industry.
2. For removing permanent hardness of water.
3. As a cleansing agent for domestic purpose.

8.6.3 Plaster of Paris

You must have seen some beautiful designs made on the ceiling and walls of rooms in many houses. These are made of plaster of paris, also called POP. Chemically, it is $2\text{CaSO}_4 \cdot \text{H}_2\text{O}$ or $\text{CaSO}_4 \cdot \frac{1}{2}\text{H}_2\text{O}$ (calcium sulphate hemi hydrate)

(a) Manufacture

Raw material

Gypsum, ($\text{CaSO}_4 \cdot 2\text{H}_2\text{O}$) is used as the raw material.

Process

The only difference between gypsum ($\text{CaSO}_4 \cdot 2\text{H}_2\text{O}$) and plaster of paris ($\text{CaSO}_4 \cdot \frac{1}{2}\text{H}_2\text{O}$) is in the less amount of water of crystallization.

When gypsum is heated at about 100° (373 K) temperature, it loses a part of its water of crystallization to form:

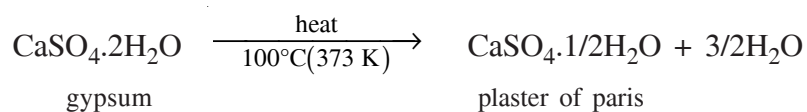

The temperature is not allowed to rise beyond 100°C otherwise whole of water of crystallization is lost and anhydrous calcium sulphate is produced which is called 'dead burnt' as it does not have the property to set after mixing with water.

(b) Uses

1. In making casts for manufacture of toys and statues.
2. In medicine for making plaster casts to hold fractured bones in place while they set. It is also used for making casts in dentistry.
3. For making the surface of walls and ceiling smooth.
4. For making decorative designs on ceilings, walls and pillars.
5. For making 'chalk' for writing on blackboard.
6. For making fire proof materials.

8.6.4 Bleaching Powder

Have you ever wondered at the whiteness of a new white cloth? How is it made so white? It is done by bleaching of the cloth at the time of its manufacture. **Bleaching** is a process of removing colour from a cloth to make it whiter. Bleaching powder has been used for this purpose since long. Chemically, it is calcium oxychloride, CaOCl_2 .

(a) Manufacture

1. **Raw material required:** The raw material required for the manufacture of bleaching powder are:

- Slaked lime, $\text{Ca}(\text{OH})_2$
- Chlorine gas, Cl_2

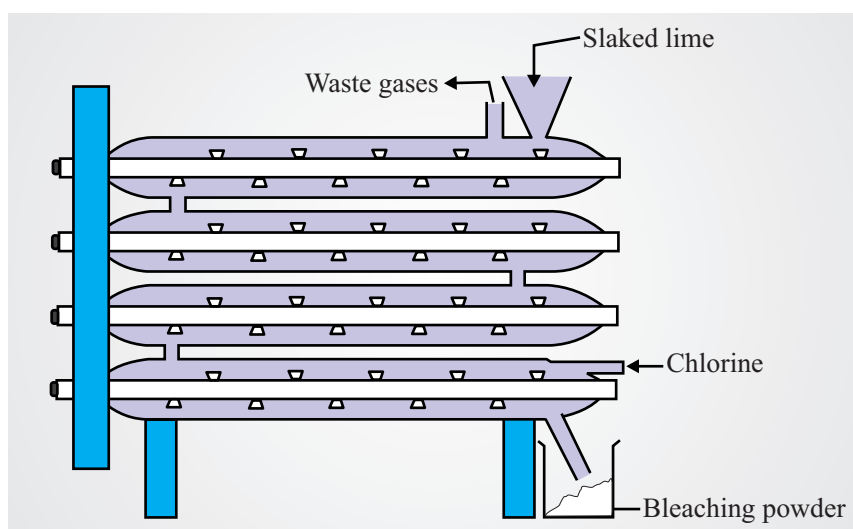

Fig. 8.10 Hasen-Clever plant for manufacturing of bleaching powder



Notes



Notes

2. **Process:** It is manufactured by Hasen-Clever Method. The plant consists of four cylinders made of cast iron with inlet for chlorine near the base. The dry slaked lime, calcium hydroxide is fed into the chlorinating cylinders from the top. It moves down slowly and meets the upcoming current of chlorine. As a result of the reaction between them, it is converted into bleaching power which collects at the bottom.

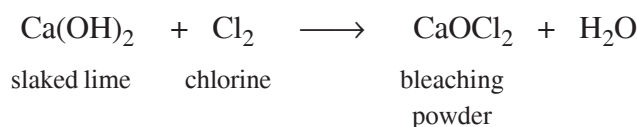

(b) Uses

1. In textile industry for bleaching of cotton and linen.
2. In paper industry for bleaching of wood pulp.
3. In making wool unshrinkable.
4. Used as disinfectant and germicide for sterilization of water.
5. For the manufacture of chloroform.
6. Used as an oxidizing agent in chemical industry.



INTEX QUESTIONS 8.5

1. Identify acid radical and basic radical in CaSO_4 .
2. CuSO_4 was prepared by reacting an acid and a base. Identify the acid and the base that must have been used in this reaction.
3. Which one of the following is the correct formula of plaster of paris?
 $\text{CaSO}_4 \cdot \text{H}_2\text{O}$ or $2\text{CaSO}_4 \cdot \text{H}_2\text{O}$



WHAT YOU HAVE LEARNT

- Acids are the substances which taste sour, change blue litmus red, are corrosive to metals and furnish H^+ ions in their aqueous solutions.
- Bases are the substances which taste bitter, change red litmus blue, feel slippery and furnish OH^- ions in their aqueous solutions.
- Indicators are the substances that show one colour in an acidic medium and another colour in a basic medium. Litmus, phenolphthalein and methyl orange are commonly used indicators.



Notes

- Acids are present in many unripe fruits, vinegar, lemon, sour milk etc., while bases are present in lime water, window pane cleaners, many drain cleaners etc.
- Aqueous solutions of acids and bases both conduct electricity as they dissociate on dissolving in water and liberate cations and anions which help in conducting electricity.
- Strong acids and bases dissociate completely in water. HCl, HBr, HI, H₂SO₄, HNO₃, HClO₄ and HClO₃ are strong acids and LiOH, NaOH, KOH, RbOH, CsOH, Ca(OH)₂, Sr(OH)₂ and Ba(OH)₂ are strong bases.
- Weak acids and bases dissociate partially in water. For example, HF, HCN, CH₃COOH etc. are some weak acid and NH₄OH, Cu(OH)₂, Al(OH)₃ etc. are some weak bases.
- Acids and bases react with metals to produce salt and hydrogen gas.
- Acids react with metal carbonates and metal hydrogen carbonates to produce salt, water and CO₂.
- Acids react with metal oxides to produce salt and water.
- Bases react with non-metal oxides to produce salt and water.
- Acids and bases react with each other to produce salt and water. Such reactions are called neutralization reactions.
- Acids and bases dissociate only on dissolving in water.
- Water itself undergoes dissociation and furnishes H⁺ and OH⁻ ions in equal numbers. This is called self dissociation of water. The extent of dissociation is very small.
- Concentrations of H⁺ and OH⁻ ion formed by the self dissociation of water are 1.0 × 10⁻⁷ molar each at 25°C.
- Product of concentrations of hydrogen and hydroxyl ions is called the 'ionic product' or 'ionic product constant' of water, Kw. It remains unchanged even when some substance (acid, base or salt etc.) is dissolved in it.
- pH is defined as $\log \frac{1}{[\text{H}^+]}$ or $-\log[\text{H}^+]$, likewise $\text{pOH} = -\log[\text{OH}^-]$ and $\text{pKw} = -\log \text{Kw}$
- In pure water or in any aqueous solution $\text{pH} + \text{pOH} = \text{pKw} = 14$ at 25°C.
- In pure water $[\text{H}^+] = [\text{OH}^-]$. It is also true in any neutral aqueous solution. In terms of pH, $\text{pH} = \text{pOH} = 7$ in water and any neutral solution.
- In acidic solution $[\text{H}^+] > [\text{OH}^-]$ and $\text{pH} < \text{pOH}$. Also $\text{pH} < 7$ at 25°C.
- In basic solutions $[\text{H}^+] < [\text{OH}^-]$ and $\text{pH} > \text{pOH}$. Also $\text{pH} > 7$ at 25°C.
- Universal indicator is prepared by mixing a number of indicators. It shows a different but characteristic colour at each pH.



Notes

- Maintenance of correct pH is very important for biochemical process occurring in humans and animals.
- If pH of rain water falls below 5.6, it is called acid rain and is quite harmful.
- pH plays an important role in proper growth of plants and also for proper digestion in our bodies.
- Salts are ionic compounds made of a cation other than H^+ ion and an anion other than OH^- ion. They are formed in neutralization reaction.
- Salts are also formed in reaction of acids and bases with metals, of acid with metal carbonates, hydrogen carbonates and oxides and in reaction of bases with non-metal oxides.



TERMINAL EXERCISE

A. Objective Type Questions

I. Mark the correct choice

1. Lemon juice contains
 - (a) tartaric acid
 - (b) ascorbic acid
 - (c) acetic acid
 - (d) lactic acid
2. Aqueous solutions of acids conduct electricity. This shows that
 - (a) They contain H^+ ions
 - (b) They contain OH^- ion
 - (c) They contain cations and anions
 - (d) They contain both H^+ and OH^- ions
3. Which of the following is not a strong acid?
 - (a) HCl
 - (b) HBr
 - (c) HI
 - (d) HF
4. Self dissociation of water produces
 - (a) a large number of H^+ ions
 - (b) a large number of OH^- ions
 - (c) H^+ and OH^- ions in equal numbers
 - (d) H^+ and OH^- ions in unequal numbers
5. In any aqueous basic solution
 - (a) $[H^+] > [OH^-]$
 - (b) $[H^+] < [OH^-]$
 - (c) $[H^+] = [OH^-]$
 - (d) $[H^+] = 0$



Notes

6. In an aqueous solution of HCl which of the following species is not present?
- (a) H^+ (b) OH^-
 (c) HCl (d) Cl^-
7. Which of the following is not a raw material for manufacturing washing soda?
- (a) Lime stone (b) Ammonia
 (c) Slaked lime (d) Sodium chloride

II. Mark the following statements as true (T) or false (F):

- Acids furnish H^+ ions only in the presence of water.
- Lime water turns blue litmus red.
- HF is a strong acid.
- H_2 gas is produced when acids react with metal oxides.
- Corrosive action of acids is due to H^+ ions present in them.
- When the pH of the rain water become more than 5.6 it is called acid rain.
- Aqueous solutions of all the salts are neutral in nature i.e. neither acidic nor basic in nature.

III. Fill in the blanks

- Acids taste while bases taste
- Milk of magnesia turns litmus
- One mole of sulphuric acid would furnish mole/s of H^+ ions and moles of SO_4^{2-} ions.
- gas is produced when acids react with metal hydrogen carbonates.
- Lime water turns milky on passing CO_2 gas due to the formation of
- The reaction between an acid and a base is known as
- Bee sting injects acid which causes severe pain and burning sensation.
- In NH_4NO_3 the acid radical is and the basic radical is
- Chemically baking soda is

B. Descriptive Questions

- What is an acid?
- Give two examples of acids found in food articles.
- What is a base?
- Give two examples of bases.



Notes

5. What are indicators?
6. What is the colour of methyl orange indicator in (i) acidic medium and (ii) basic medium.
7. Why do solutions of acids and bases conduct electricity?
8. Differentiate between strong and weak acids and give one example of each.
9. Write down the reaction between zinc and sulphuric acid.
10. Which gas is evolved when an acid reacts with metal carbonates? Which other category of compounds would produce the same gas on reacting with acids?
11. What type of oxides react with acids? Give one examples of this type of oxide and write down the balanced equation for the reaction.
12. What is the name given to the reaction between an acid and a base? What are the products formed in such reactions?
13. "Corrosive action of acids is not related to their strength". Justify this statement.
14. Give one example each of the following (i) a strong base (ii) a weak base
15. List three categories of substances that can react with a base. Give one example of each and write the chemical reaction involved in each case.
16. What happens when a dry strip of each of red litmus paper and blue litmus paper is brought in contact with HCl gas? In which case a change would be observed if the strips are moistened and then brought in contact with HCl gas and what would be the change?
17. A small palette of NaOH is kept on dry red litmus paper. Initially, no change is observed but after some time its colour starts changing to blue around the place where the palette of NaOH is kept. Explain these observations.
18. How does water help in dissociation of acids and bases? Explain.
19. What is 'self dissociation of water'? Name the resulting species and give their concentrations at 25°C.
20. What is ionic product constant of water? Give its value at 25°C. Will the value change if an acid, base or a salt is dissolved in water?
21. Give the relationships between the concentrations of hydrogen ions and hydroxyl ions in (i) pure water (ii) a neutral solution (iii) an acidic solution and (iv) a basic solution.
22. What is pH? What happens to the pH if the hydroxyl ion concentration in the solution increases?
23. Predict whether a given aqueous solution is acidic, basic or neutral if its pH is (a) 7.0, (b) 11.9 and (c) 3.2.
24. Calculate the pH of 1.0×10^{-4} molar solution of HNO_3 .



Notes

25. What is the pH of 1.0×10^{-5} molar solution of KOH?
26. What is the pH of 1.0×10^{-2} mol L⁻¹ solution of NaCl?
27. What do you understand by the term 'universal indicator'?
28. What is acid rain?
29. What is the importance of pH for humans and animals, and our digestive system?
30. Which chemical causes pain and burning sensation when somebody accidentally touches 'nettle plant'?
31. What is a salt? Give two examples.
32. How are salts obtained from an acid? Mention four types of substances that can be used for it.
33. Give chemical formula of (i) baking soda and (ii) washing soda.
34. List the raw materials required for the manufacture of baking soda and describe the process with the help of suitable chemical equations.
35. Distinguish between baking powder and baking soda. Why is baking powder preferred for making cakes?
36. Give any two uses of baking soda.
37. What is washing soda? Give its chemical formula. How is it manufactured by Solvey's method?
38. Give two uses of washing soda.
39. What is the chemical formula of 'plaster of paris'? How is it manufactured? What precaution is taken during its manufacture?
40. List any four uses of 'plaster of paris'.
41. What is bleaching? Chemically, what is bleaching powder? Give its any four uses.
42. List the raw materials required and the method of manufacture of bleaching powder. Write the equation for the reaction involved.



ANSWERS TO INTEXT QUESTIONS

8.1

1. Acidic : (b), (c) and (e)
Basic : (a), (d) and (f)
2. Phenolphthalein: Colourless on unripe apple and pink in solutions of caustic soda and soap.
Litmus: Red on unripe apple and curd, and blue in solutions of caustic soda and soap solution.



Notes

8.2

- (a) Vinegar (b) tamarind
- (b) and (d)
- It must be a metal.
- It may be either a metal carbonate or hydrogen carbonate.
- SO₂

8.3

- It is because HCl gas does not contain H⁺(aq) ions and is non acidic
- The heat released in dissolution process help in the dissociation process by overcoming the forces that hold the hydrogen atom or the hydroxyl group in the molecules of the acid or the base, or in breaking the chemical bond holding them.
 - Presence of water weaken the electrostatic forces between anion and cations.
- Solution A – basic
 - Solution B – acidic
 - Solution C – neutral

8.4

- Since $\text{pH} + \text{pOH} = 14$
 $\text{pH} = 14 - \text{pOH} = 14 - 5.2$
 $= 8.8$

Since $\text{pH} > 7.0$, it is basic in nature
- $\text{pH} = -\log[\text{H}^+] = 9$
 $\therefore \log[\text{H}^+] = -9$
 or $[\text{H}^+] = 10^{-9} \text{ mol L}^{-1}$
- Solution A — neutral
 - Solution B — basic (since $[\text{H}^+] < [\text{OH}^-]$ in it)
 - Solution C — acidic (since $[\text{H}^+] > [\text{OH}^-]$ in it)

8.5

- Acid radical SO₄²⁻
 Basic radical Ca²⁺
- Acid: H₂SO₄ (corresponding to the acid radical SO₄²⁻)
 Base: Cu(OH)₂ (corresponding to the basic radical Cu²⁺)
- (a) Carbonates (b) potassium salts
- 2CaSO₄·H₂O

MODULE - 3
MOVING THINGS

9. Motion and its Description
10. Force and motion
11. Gravitation

